

# ALDUO TUINSCHERM - PANNEAU



Montagehandleiding

---

Notice de montage



**EXTERIORLIVING**  
BY VALCKE

# 01. ONDERDELEN - ACCESSOIRES

1	Alduo plank tand en groef - aluminium RAL 7005 - 180 cm (11 planken per scherm van 180 cm)	Planche Alduo tenon et mortaise - aluminium RAL 7005 - 180 cm (11 planches par panneau de 180 cm)
2	Alduo bovenplank aluminium RAL 7005 - 180 cm (1 plank per scherm van 180 cm)	Planche Alduo supérieure - aluminium RAL 7005 - 180 cm (1 planche par panneau de 180 cm)
3	Alumium beginpaal systeem 20 mm RAL 7005	Poteau de départ système 20 mm en aluminium RAL 7005
4	Alumium gleufpaal systeem 20 mm RAL 7005	Poteau intermédiaire système 20 mm en aluminium RAL 7005
5	L-hechtingen	L-attaches
6	Zelfborende schroef inox 3,9 x 28 mm	Vis autotaraudeuse inox 3,9 x 28 mm

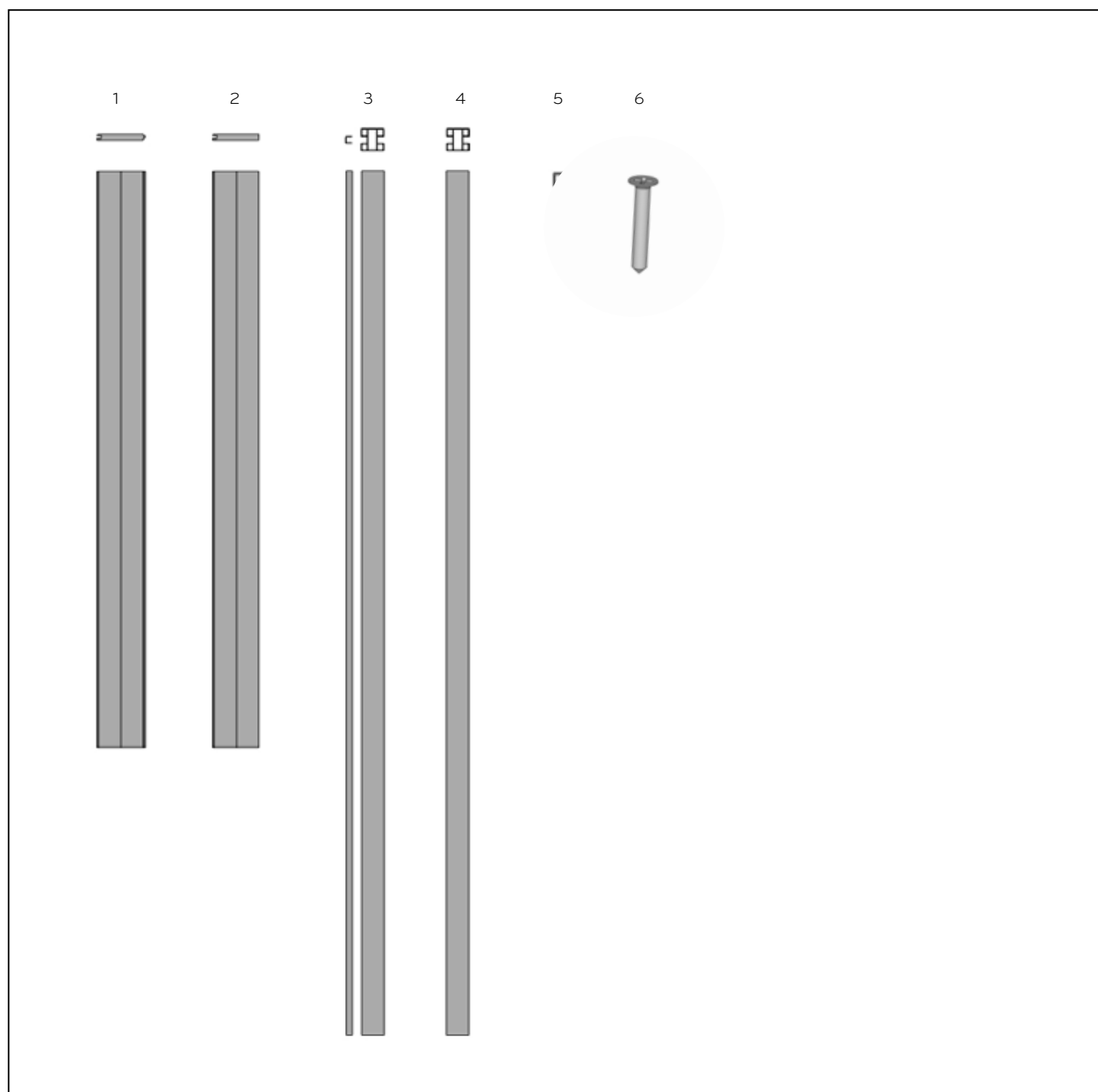

## 02. MONTAGE TUINSCHERM - POSE PANNEAU

01

Klik een insteekdop op de **onderzijde** van elke paal.

Installez une chapeau de recouvrement **au bas** de chaque poteau.

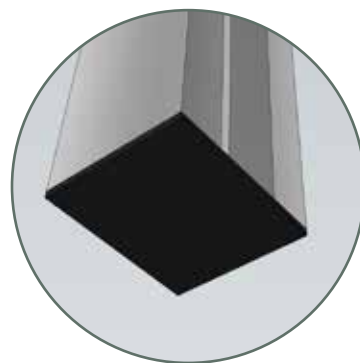

02

Schuif een U-profiel in elke begin- en eindpaal.

Glissez un profil U dans chaque poteau de départ et chaque poteau de fin.

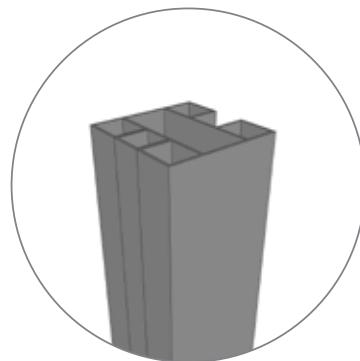
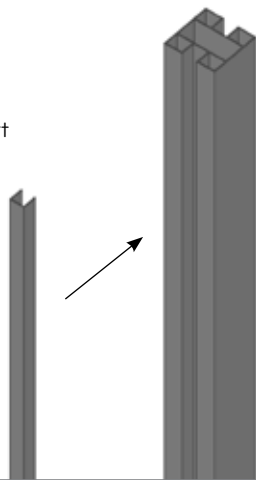

03

Plaats de aluminium palen systeem 20 mm op 177 cm van elkaar.

Installez les poteaux en aluminium système 20 mm à 177 cm de distance.

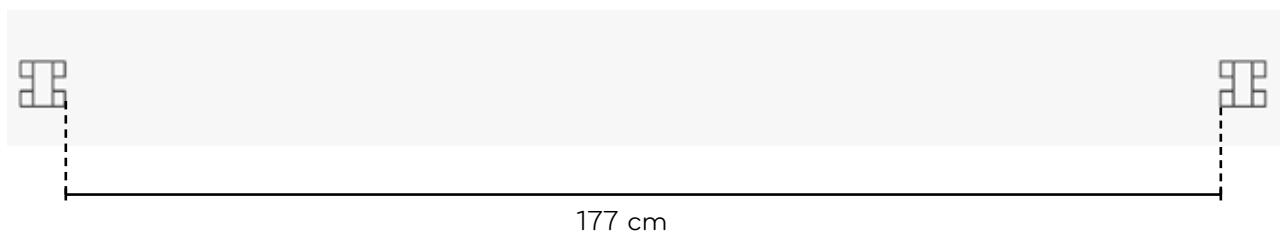

04

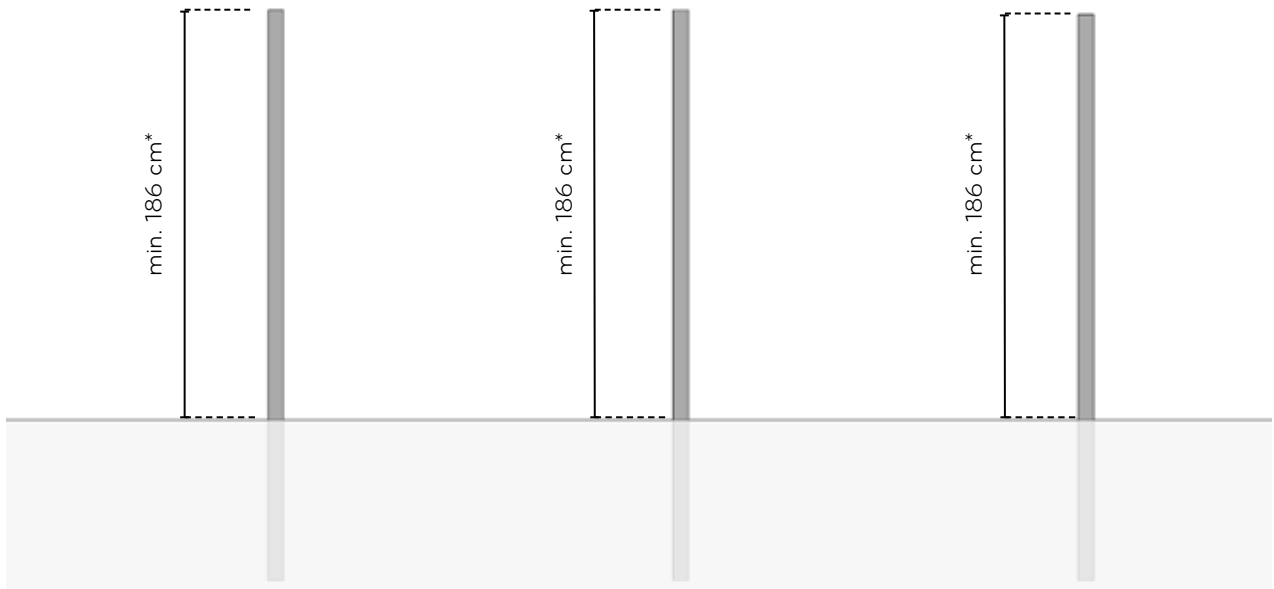

#### BELANGRIJK

\* Plaats de palen **minimum** 186 cm hoog boven de grond.  
Totale hoogte hangt af van de plaatsing van de L-hechting.

#### IMPORTANT

\* Installez les poteaux **au moins** 186 cm du sol.  
La hauteur totale dépend de l'emplacement de la attache L.

05

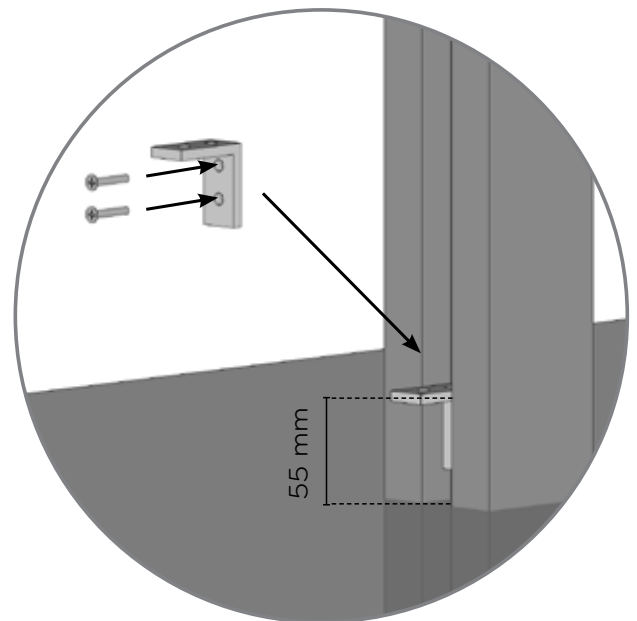
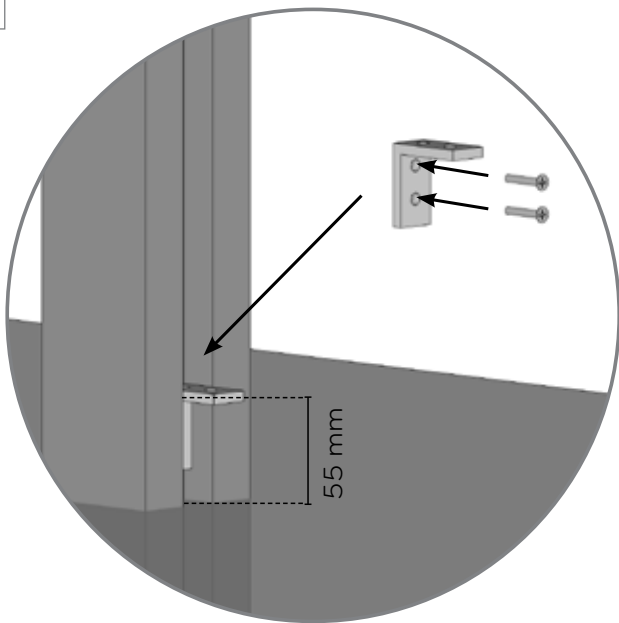

3,9 x 28



06

**TIP**

Plaats de planken met voorzichtigheid tussen de palen om krassen te voorkomen. Vermijd het schuiven van de planken door ze meteen op de correcte hoogte te plaatsen.

**CONSEIL**

Placez les planches soigneusement entre les poteaux pour éviter les rayures. Évitez de faire glisser les planches en les plaçant immédiatement à la bonne hauteur.

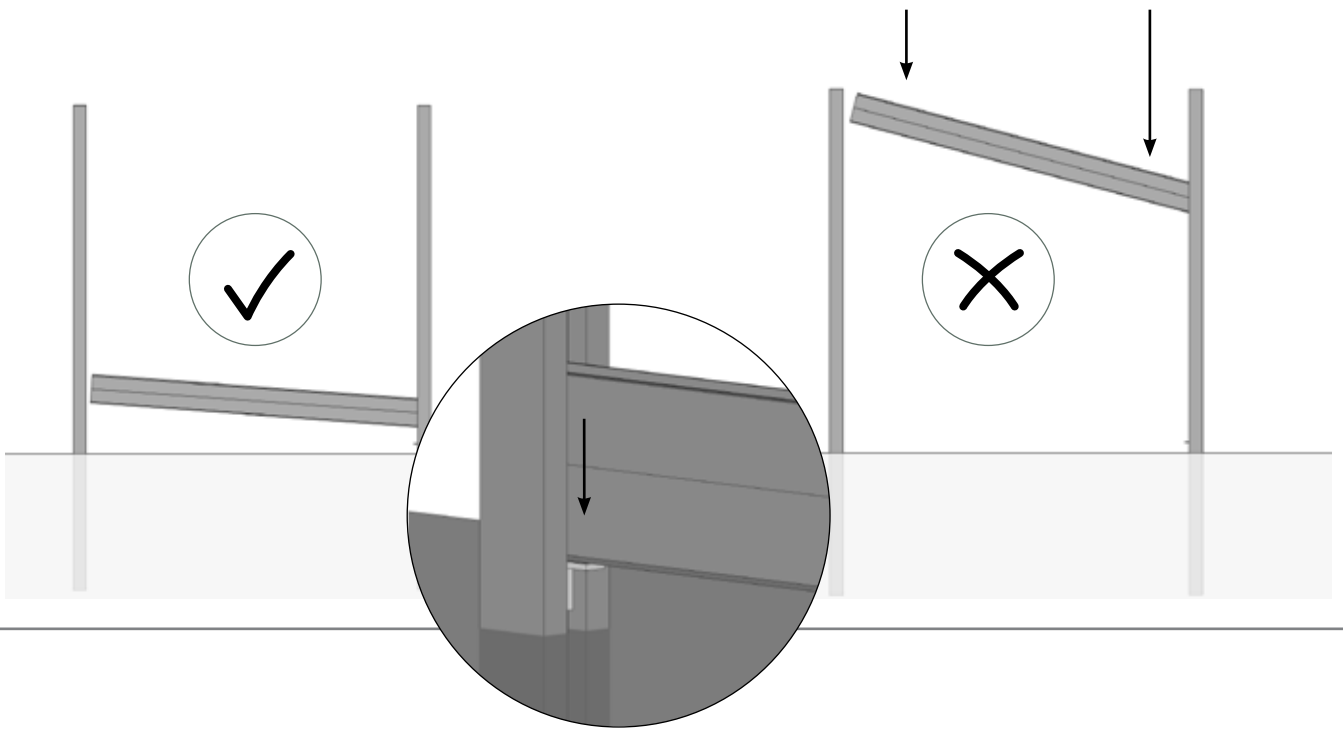

07

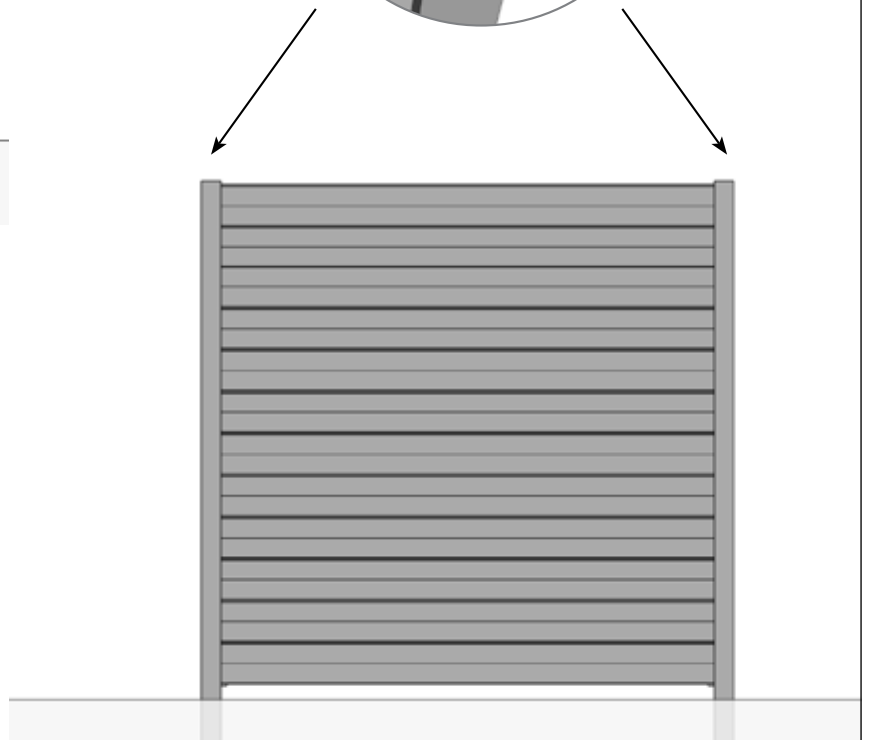
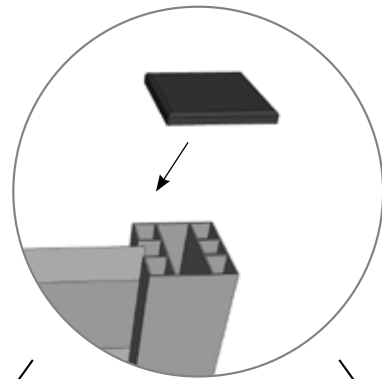
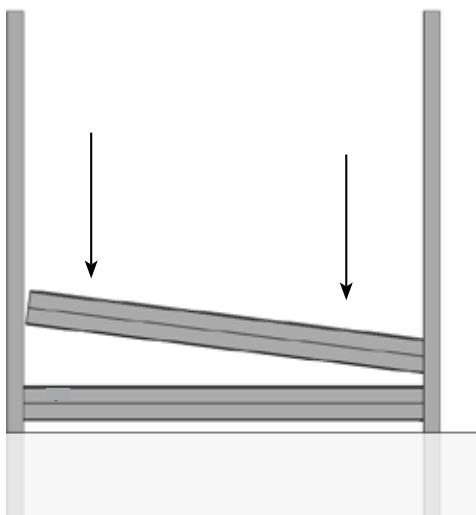



[www.exteriorliving.be](http://www.exteriorliving.be)

Bruggesteeweg 245, B-8830 Gits  
T +32 (0)51 21 13 48 - [info@exteriorliving.be](mailto:info@exteriorliving.be)  
[www.exteriorliving.be](http://www.exteriorliving.be)

inspired  
by

