

# PN19 - Traditioneel / Traditionnel / Traditional

met voordak 80 cm / avec avancée 80 cm / with front roof 80 cm

Montagehandleiding  
Notice de montage  
Manual

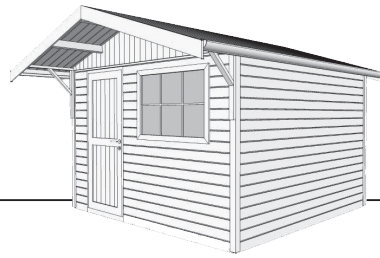

[www.tack.be](http://www.tack.be)

V01.130812

01

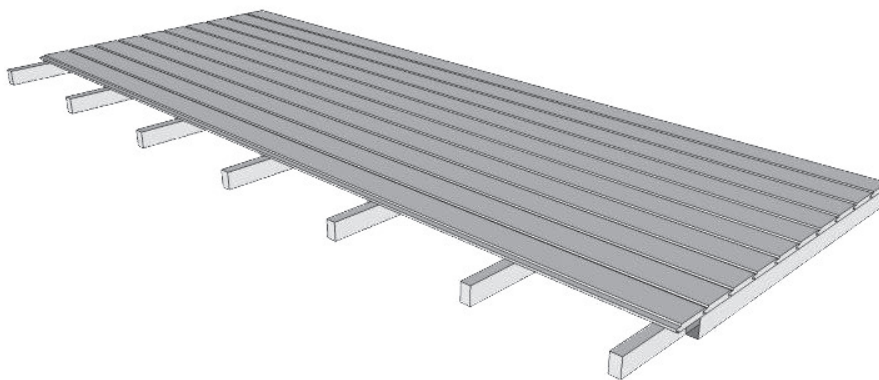

02

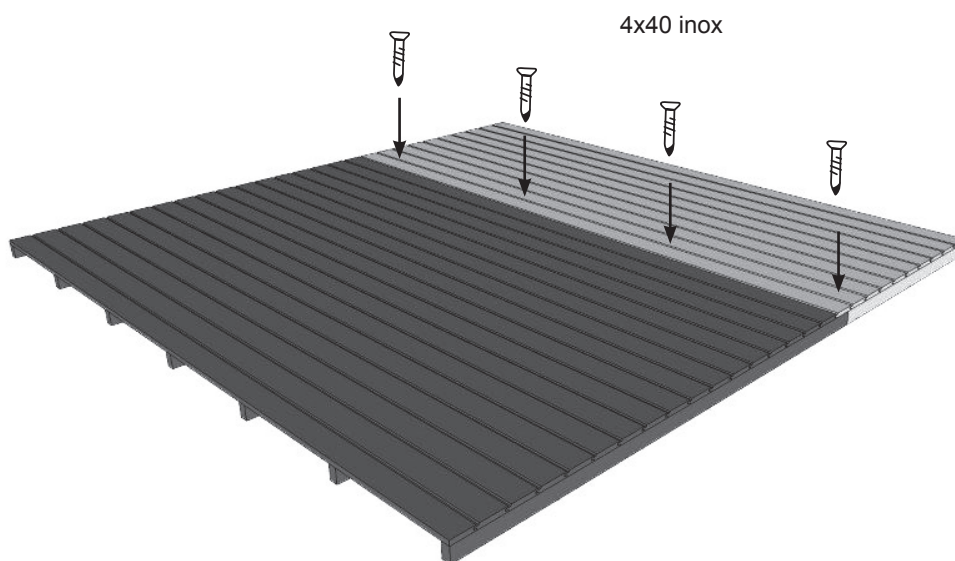

03

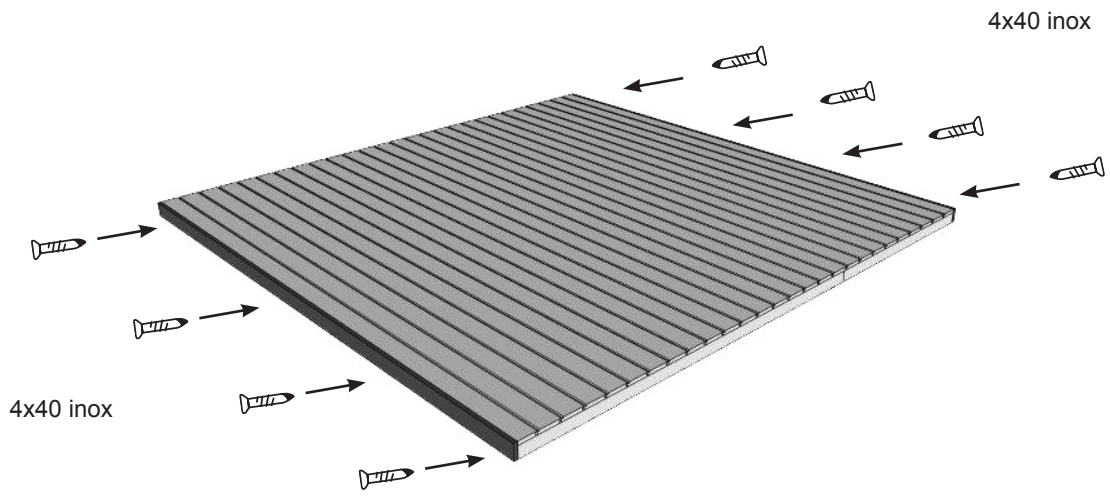

04

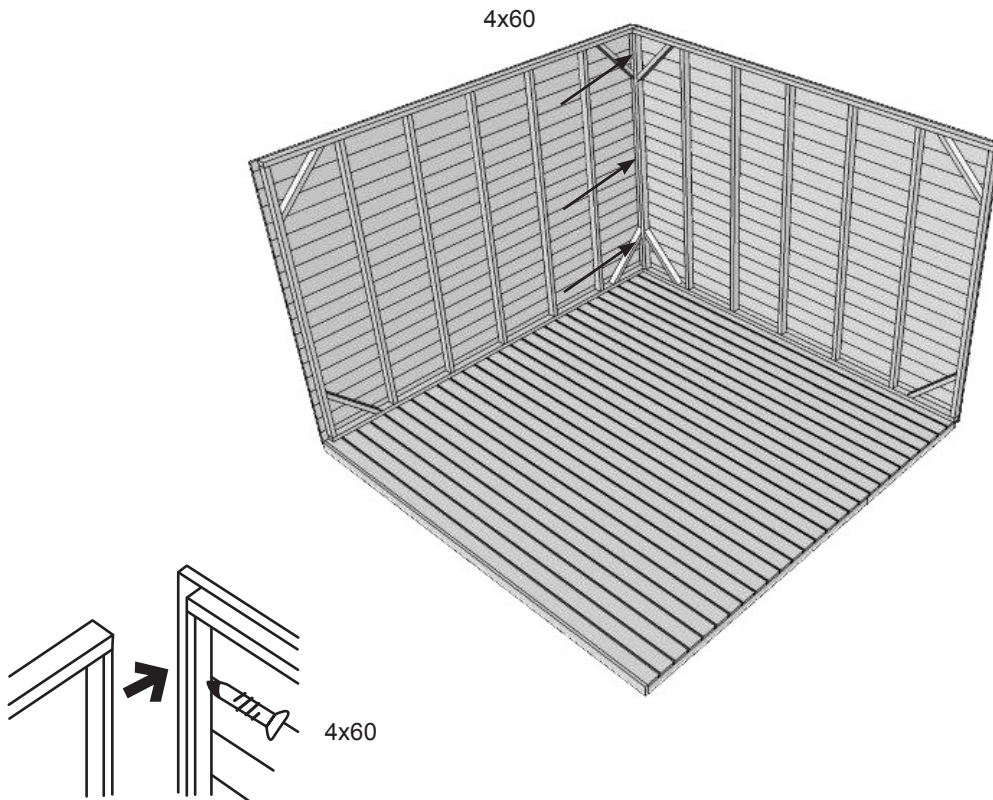

05

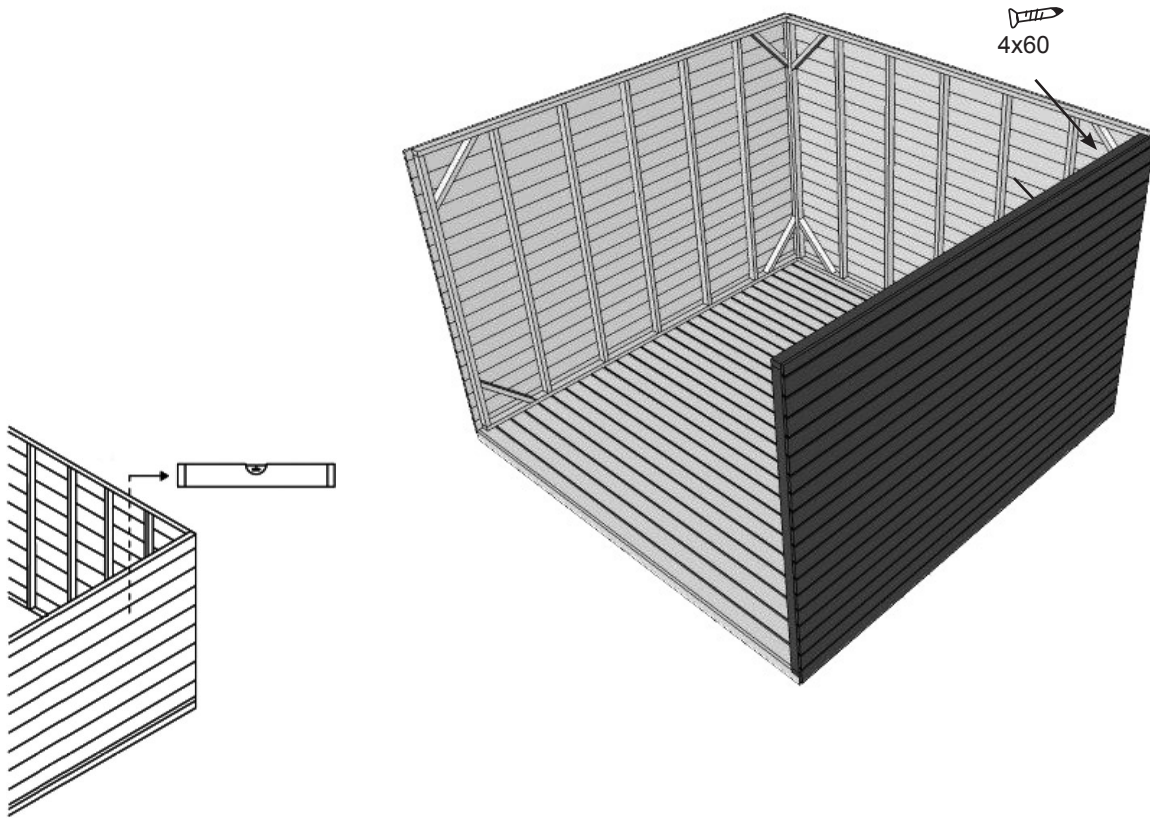

06

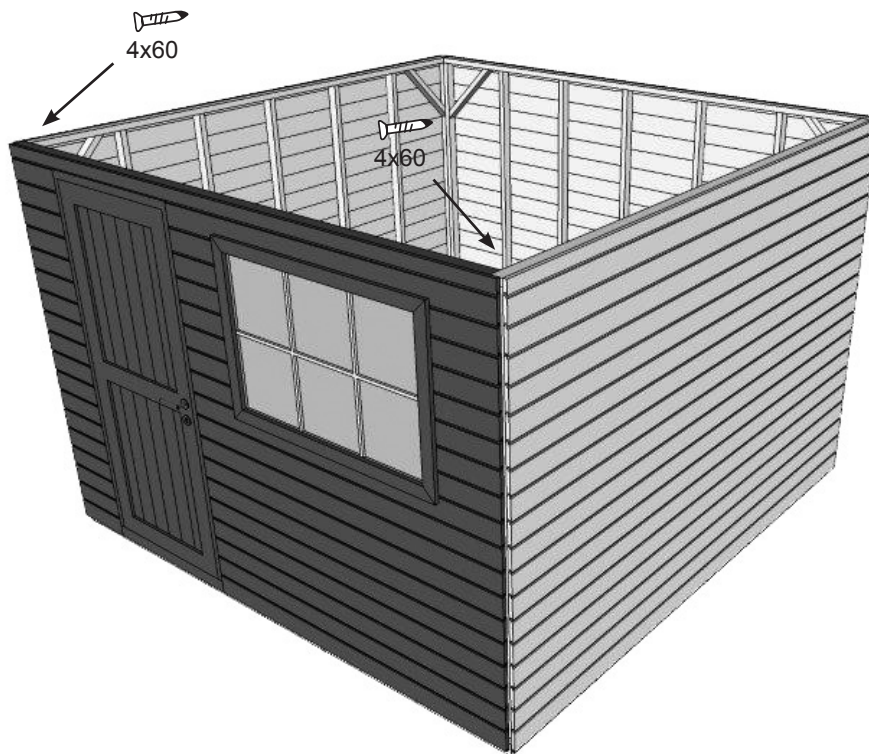

07

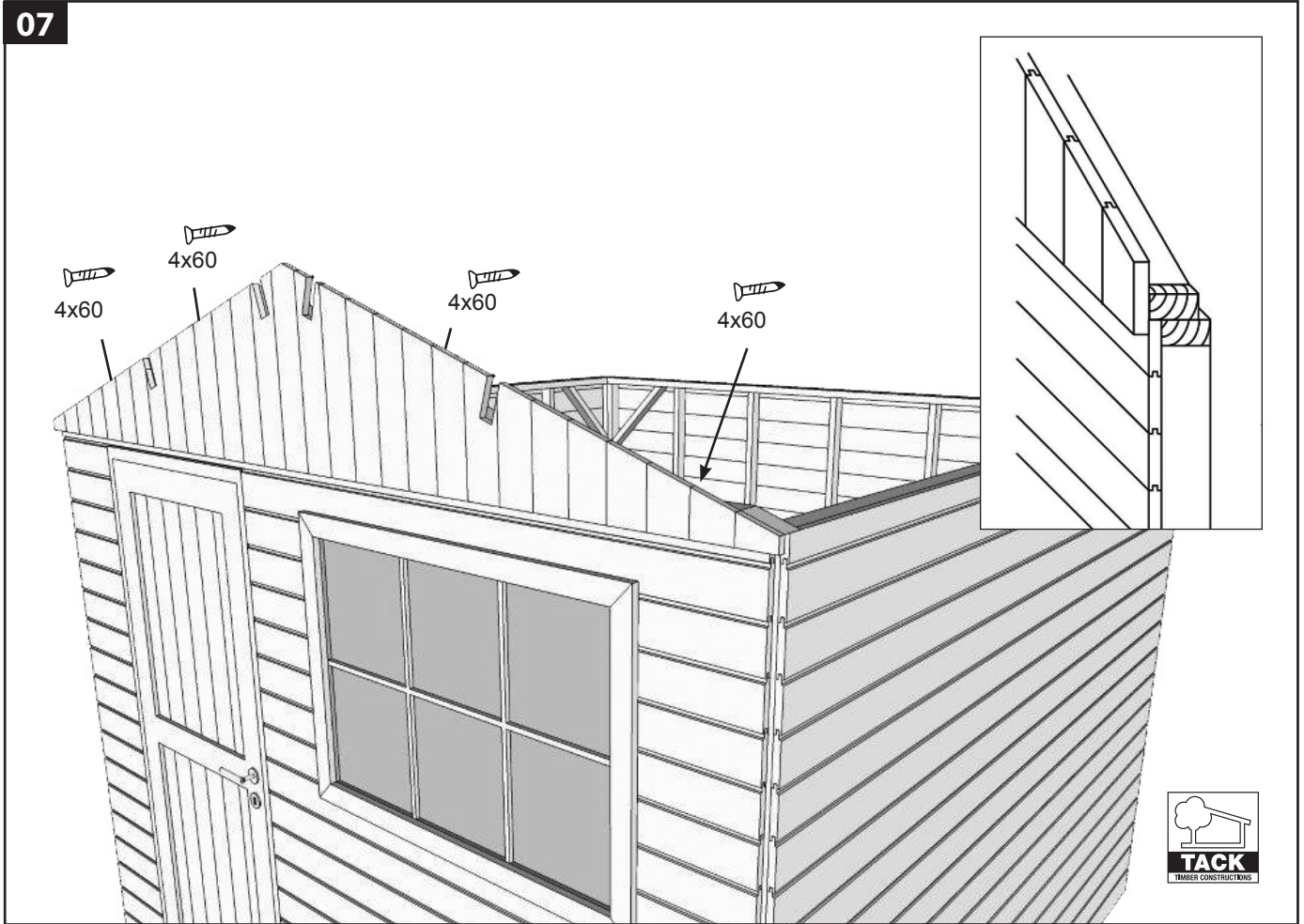

08

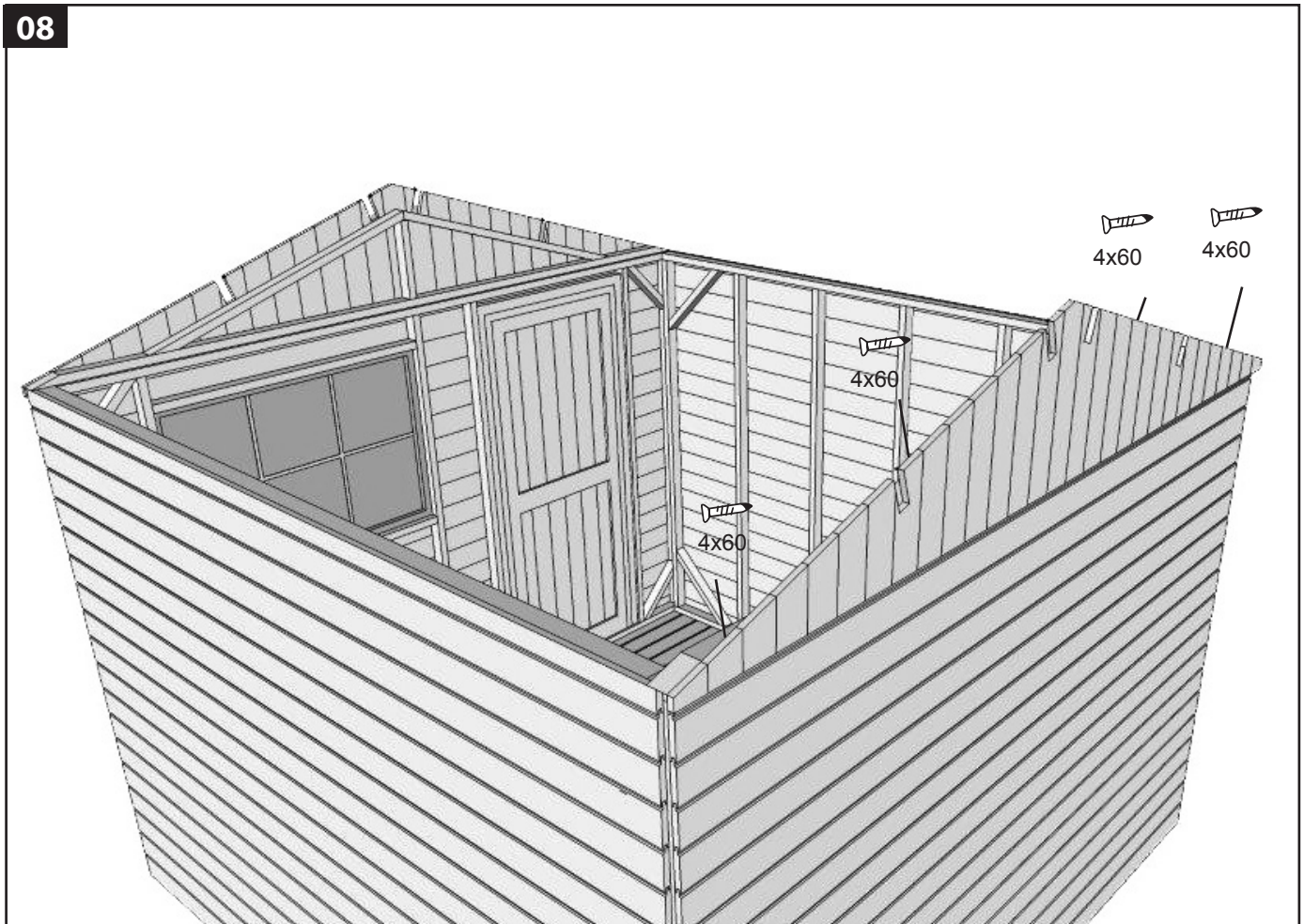

09

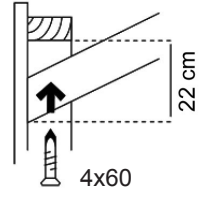

10

4x60

4x60

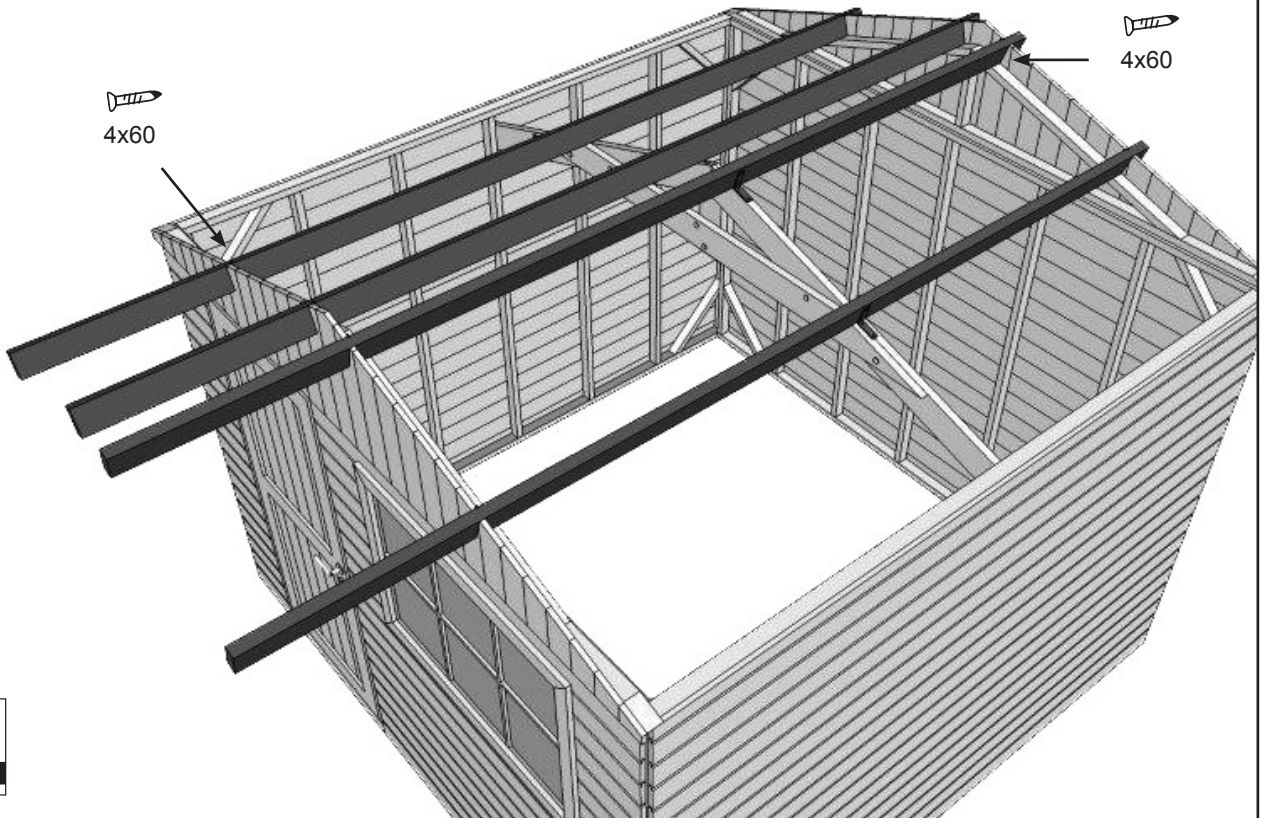

11

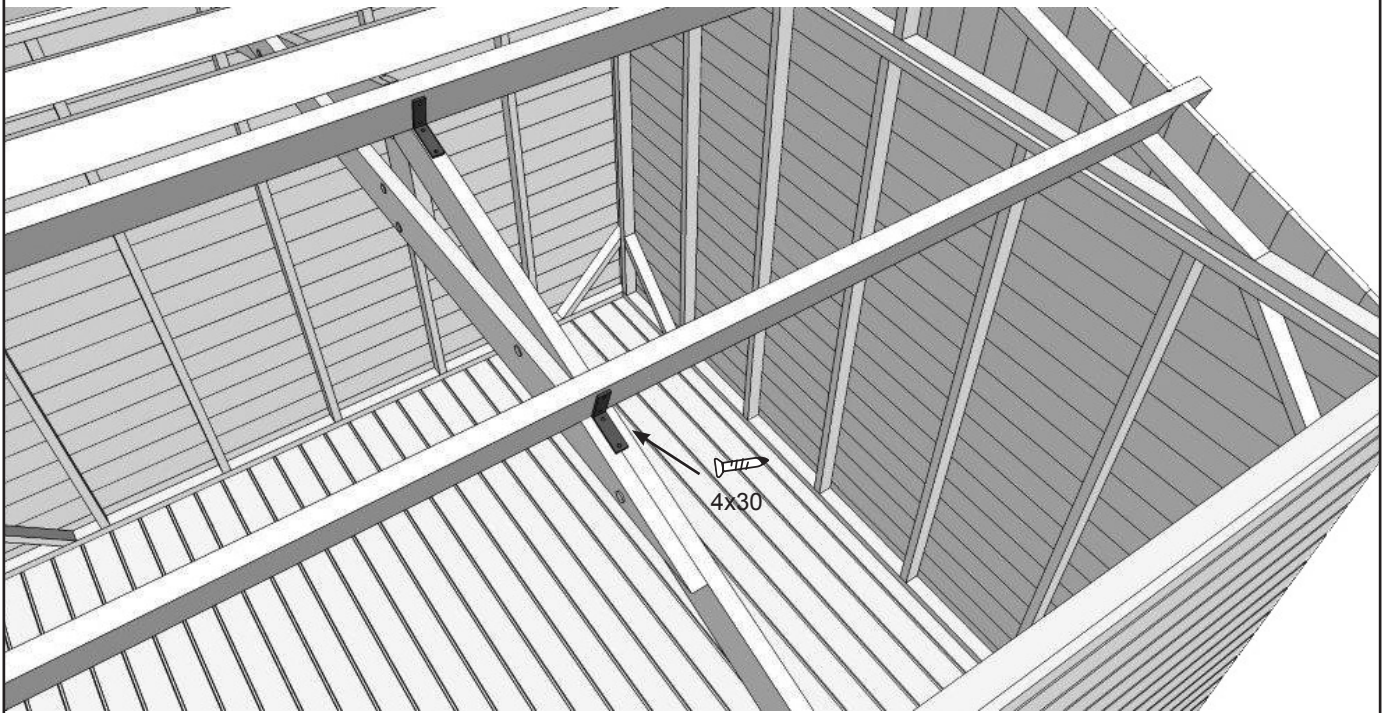

12

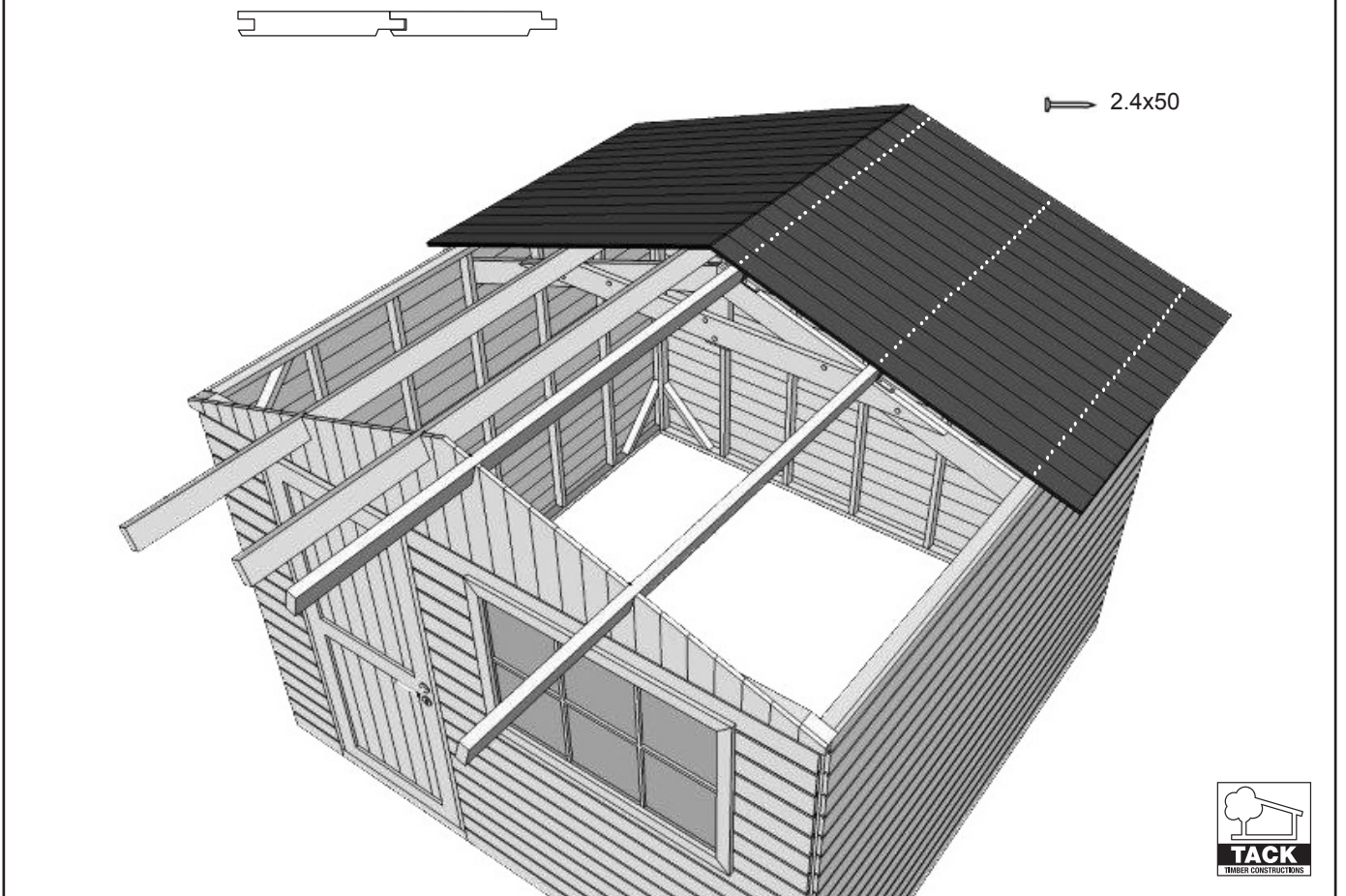

13

2.4x50

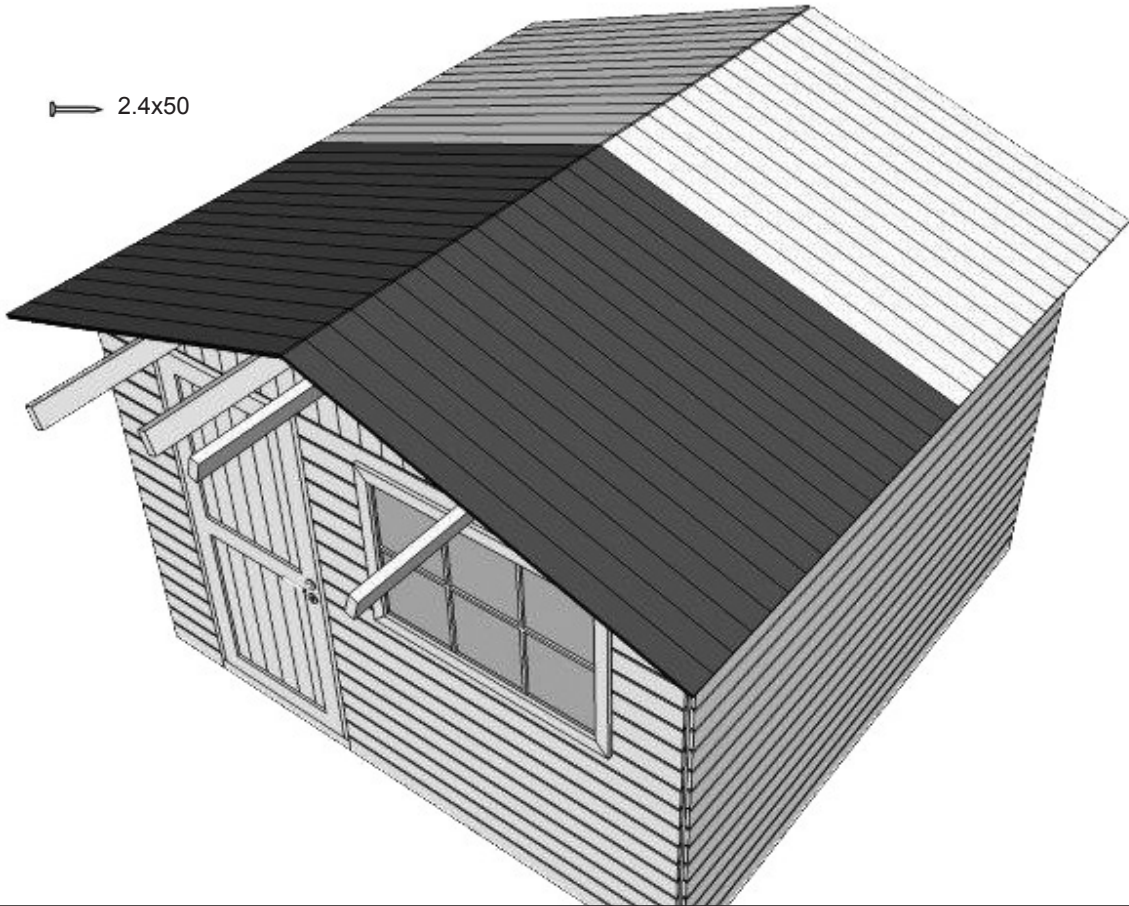

14

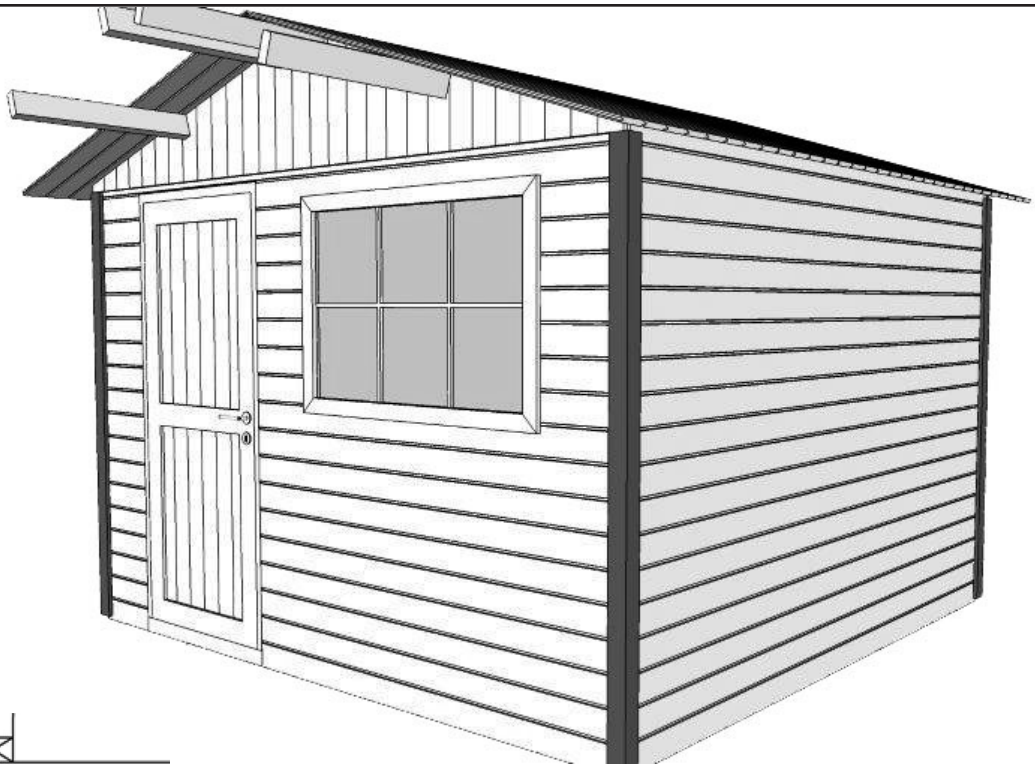

4x40 inox

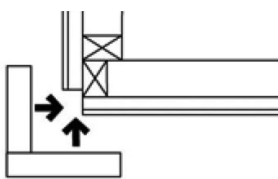

4x40 inox



15

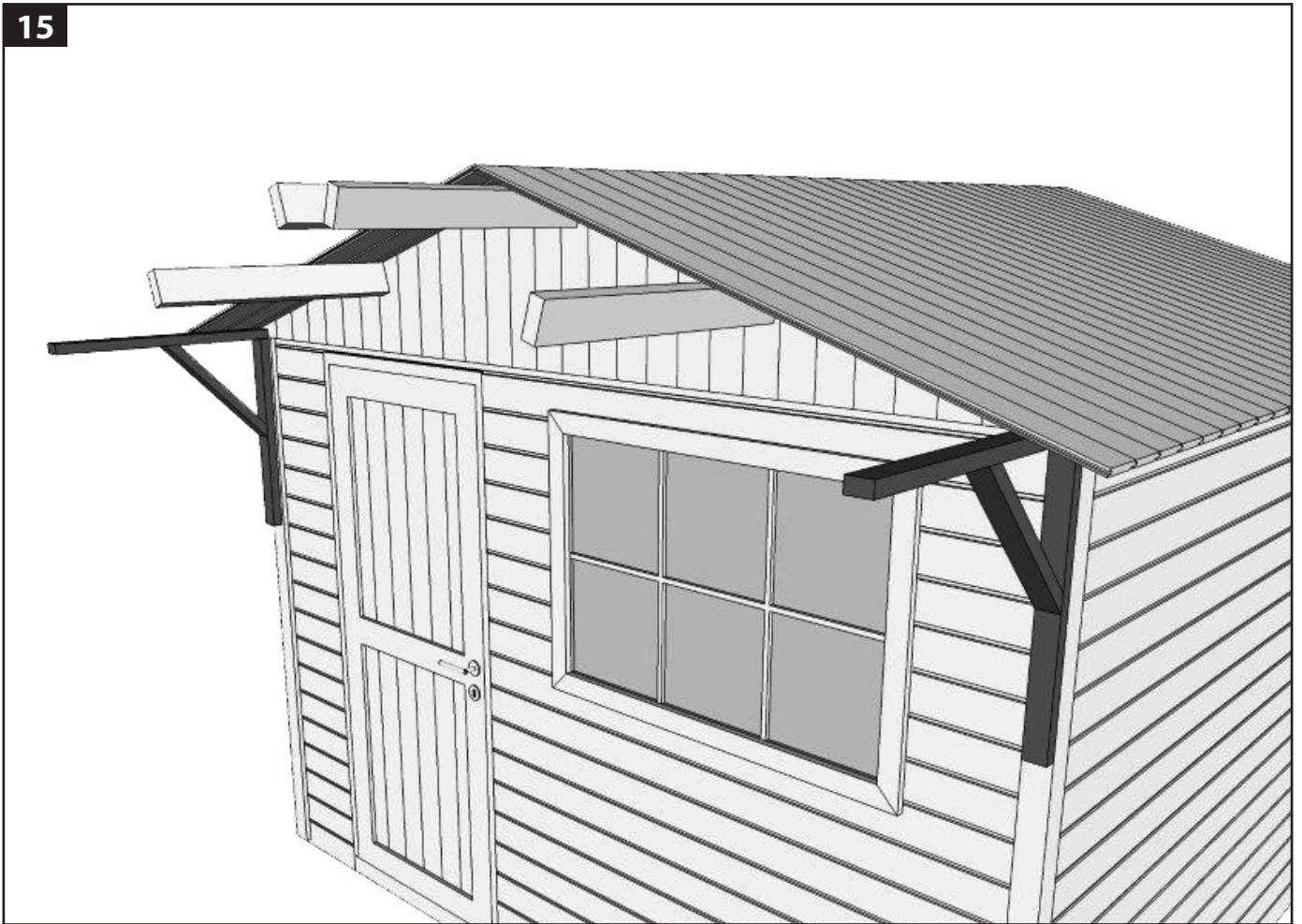

16

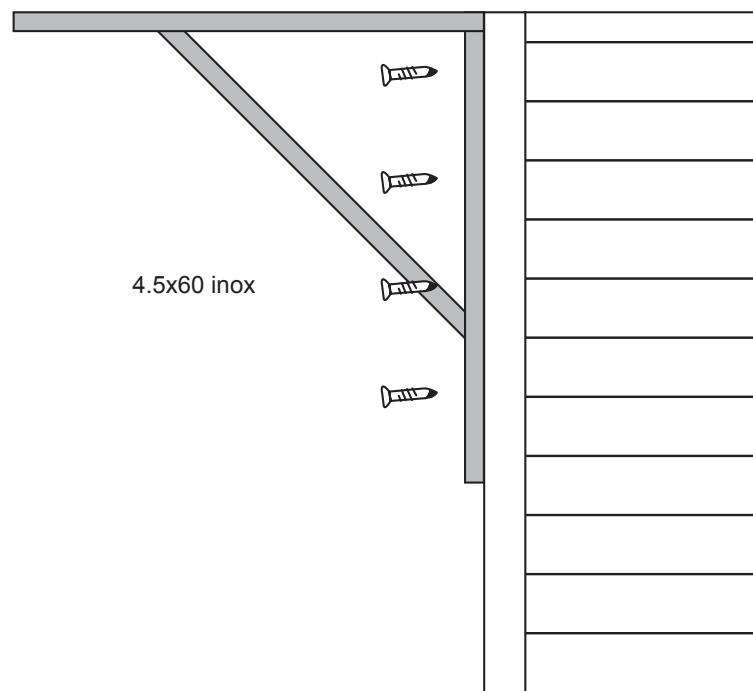



17

2.4x50

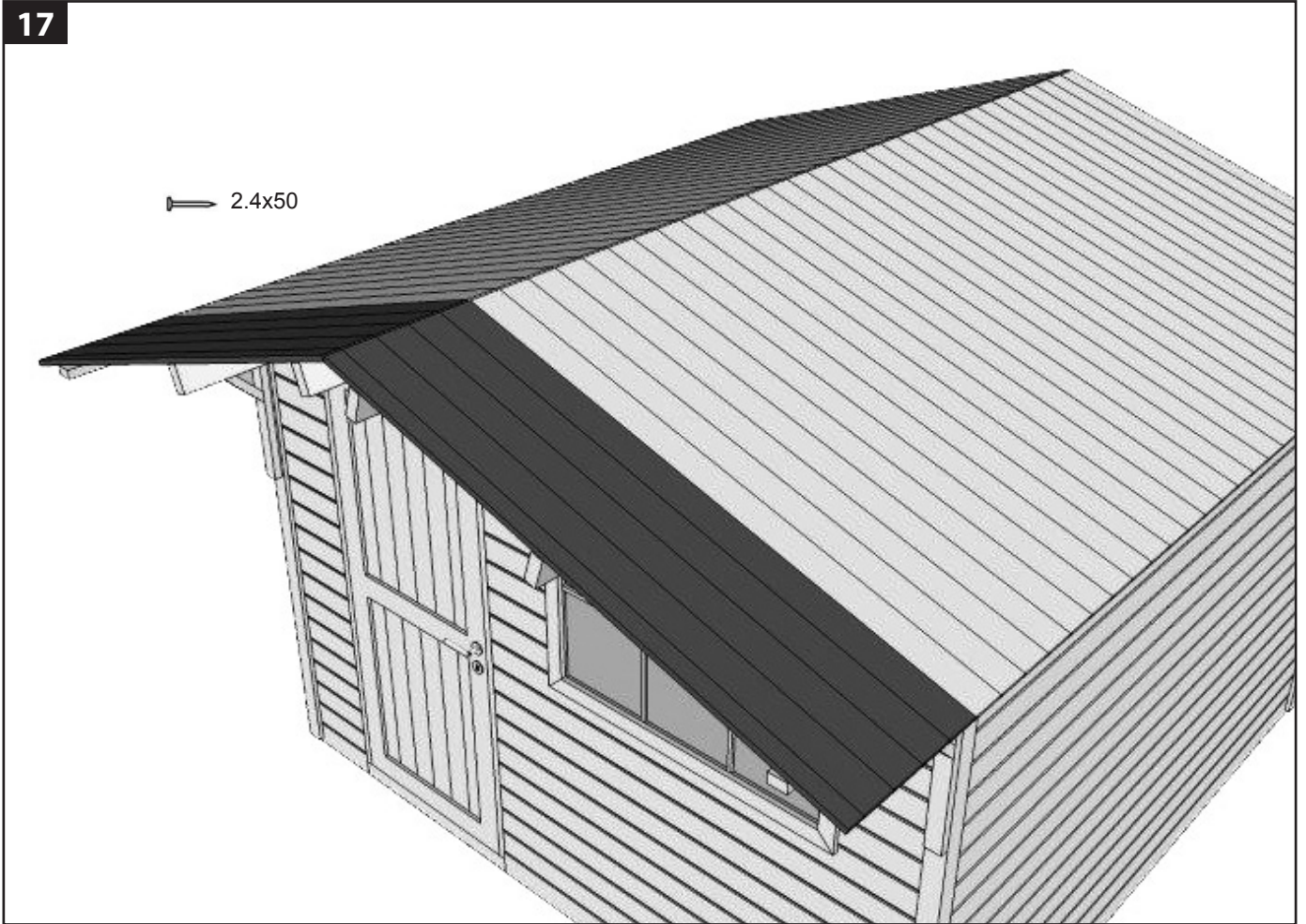

18

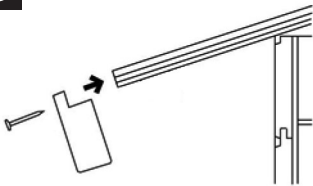

4x40 inox

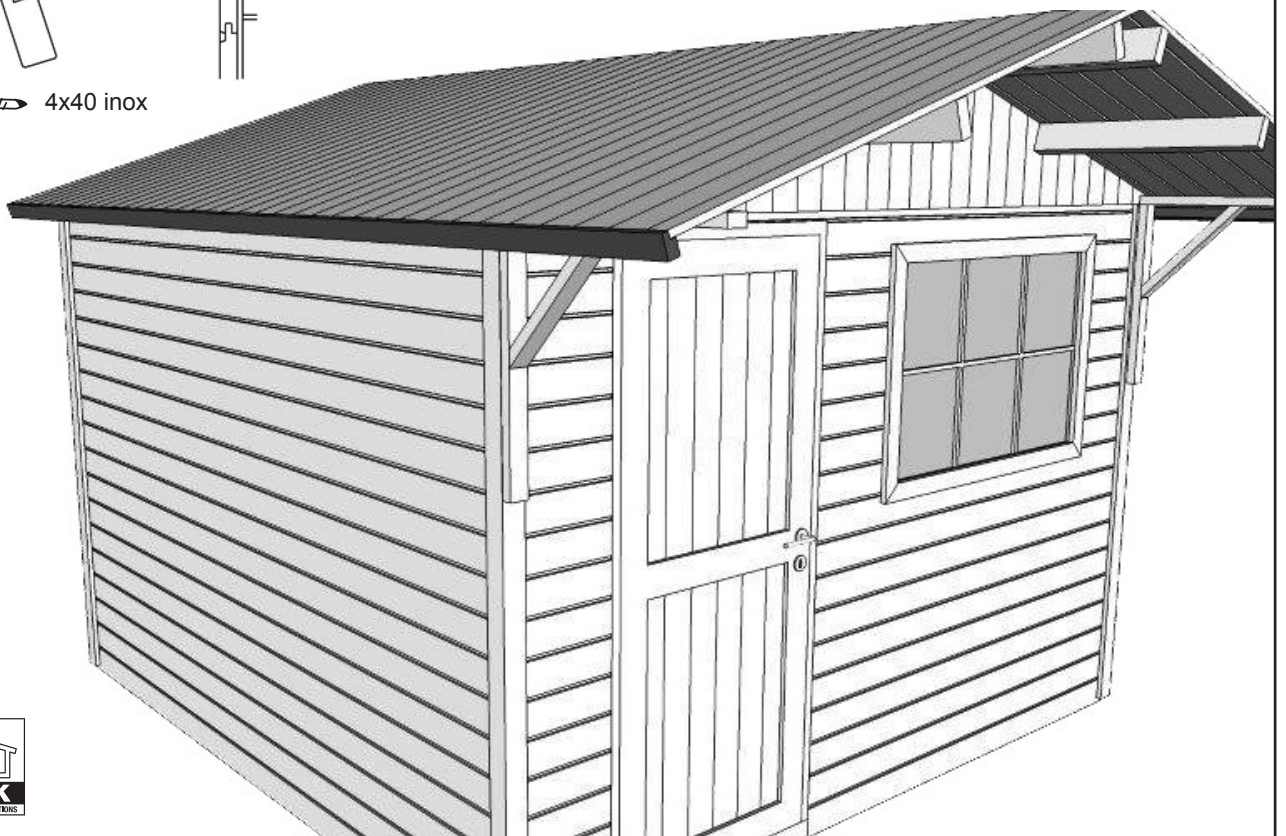

19

## optie met goot

4x40 inox

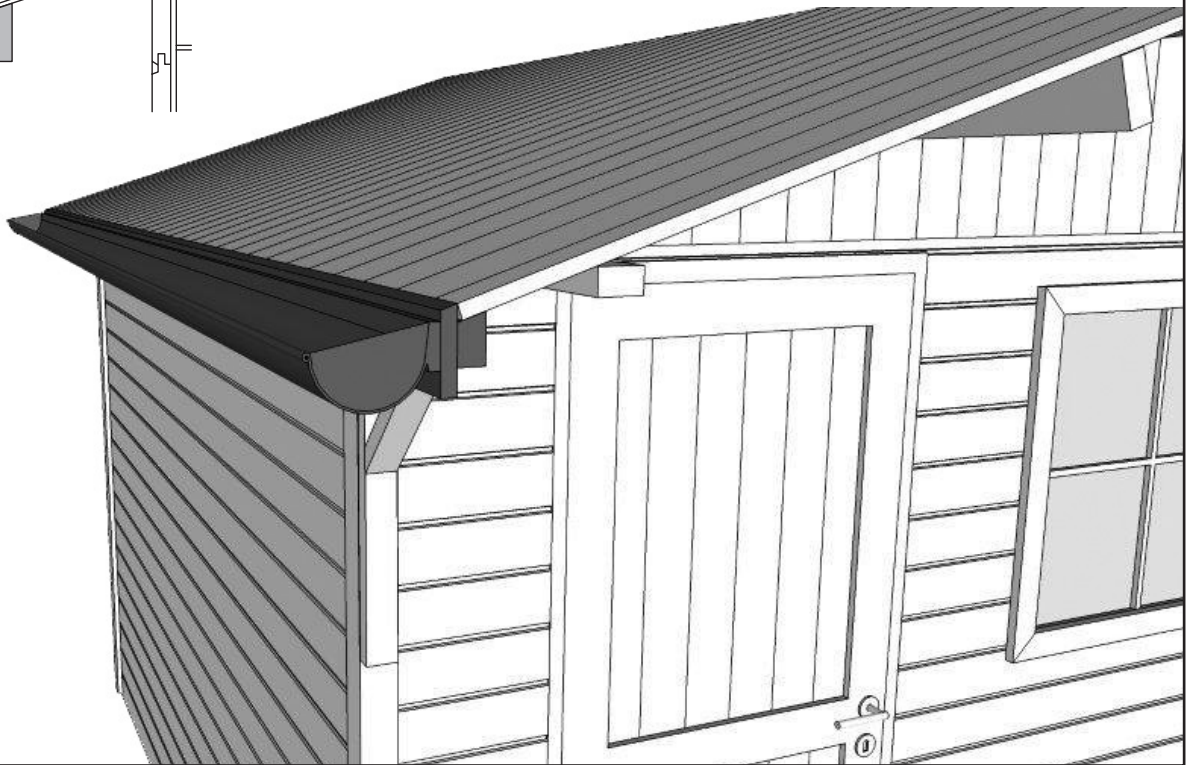
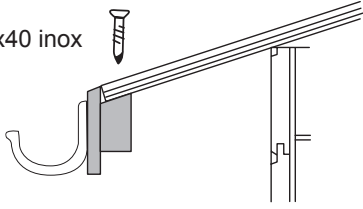

20



4x40 inox

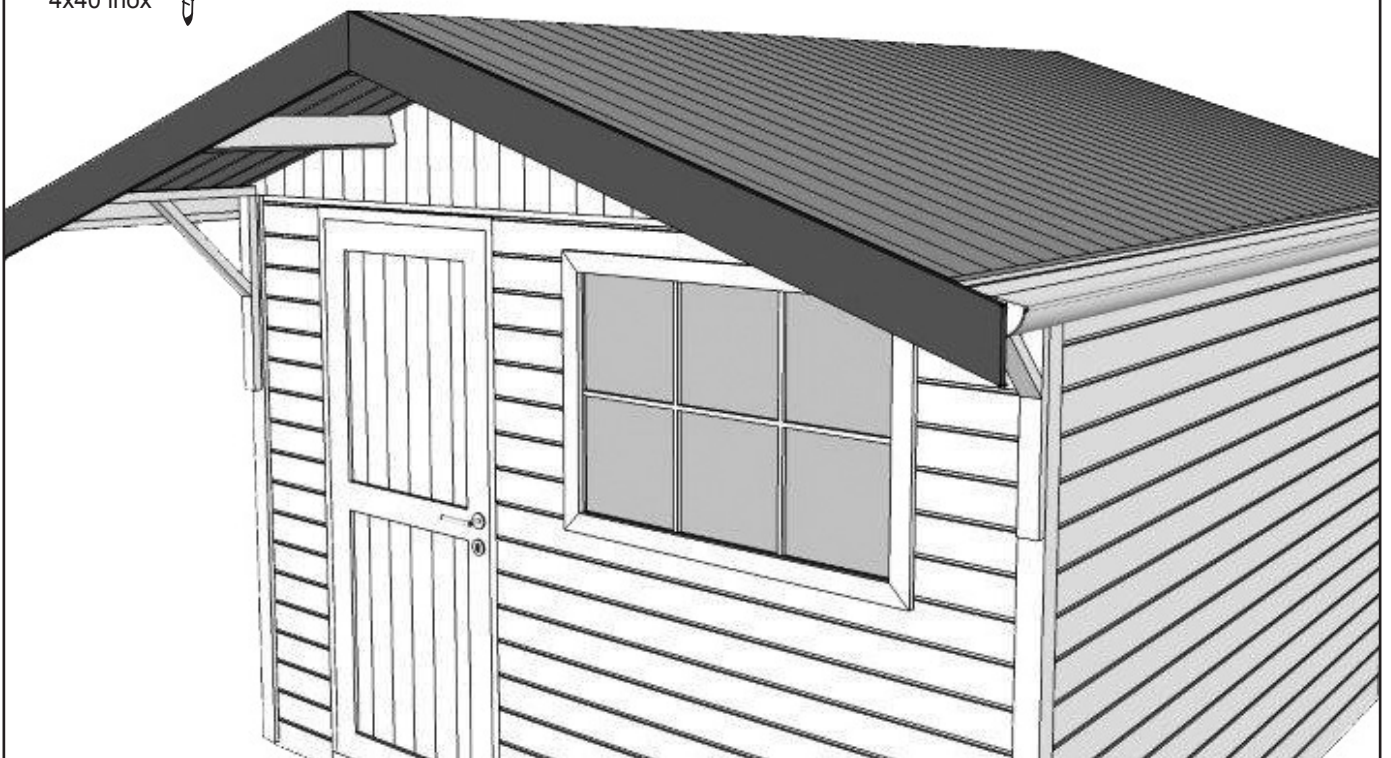

21

## optie met dakpanplaten

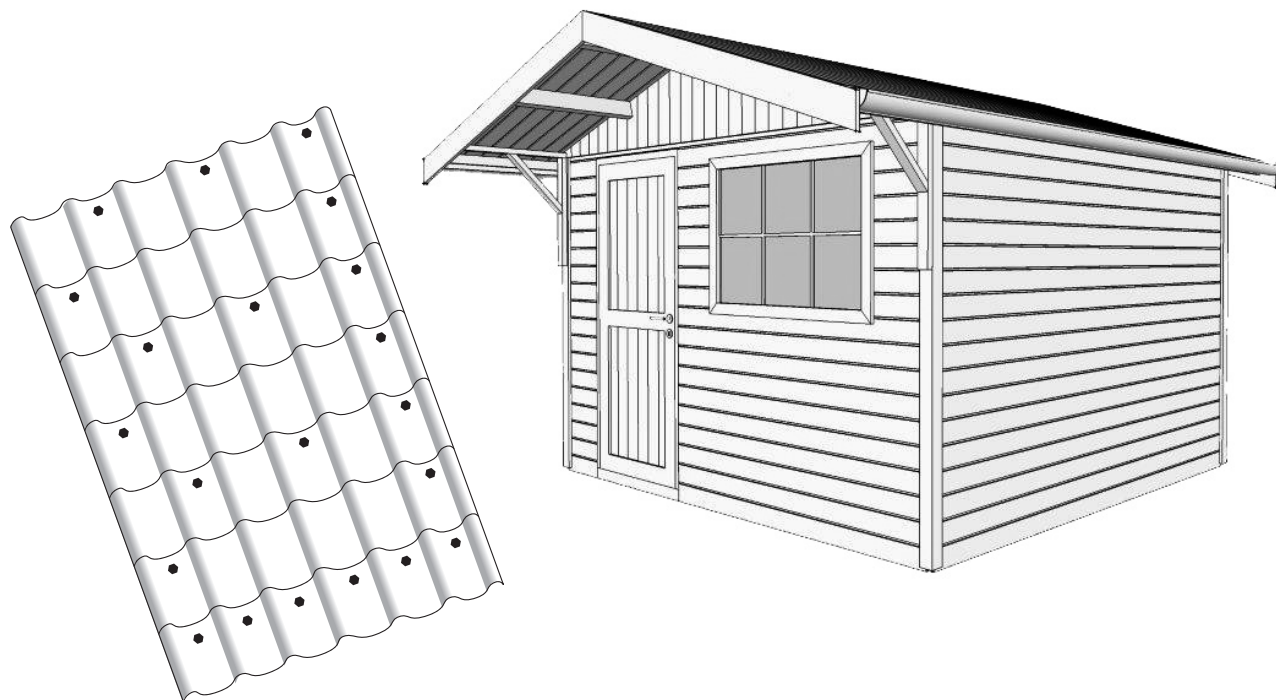



[www.tack.be](http://www.tack.be)