



Vintage

Voorgevel—Façade—Facade—Fachada—Vorderseite : 365

STPL

VOZ092016

INLEIDING / INTRODUCTION / INTRODUCCION / INTRODUCCIÓN / EINLEITUNG

Hartelijk gefeliciteerd met uw Gardival® VINTAGE. Uw tuinhuis VINTAGE is vervaardigd uit kwaliteitsvol Noord-Europees grenen, dat al dan niet in druk werd geïmpregneerd. Hierbij vindt u de handleiding om uw VINTAGE zelf te plaatsen. Het is aan te raden deze brochure eerst aandachtig te lezen voordat u met de plaatsing van de VINTAGE begint. Indien u nog problemen zou hebben, verwijzen we u graag door naar uw Gardival® verkoper, die u graag met raad en daad zal bijstaan.

Volgende hulpmiddelen zijn nuttig om bij de hand te hebben om uw VINTAGE vlot te plaatsen:

schroevendraaier - waterpas - potlood - boormachine - (vouw)meter

Veel succes met het plaatsen van uw VINTAGE.

Nous vous remercions pour votre achat d'un VINTAGE Gardival®. Votre abri VINTAGE est fait dans un bois de qualité le Sapin Rouge du Nord, éventuellement ce bois est traité sous pression. Ci-joint vous trouvez la notice de montage pour vous faciliter la pose de votre VINTAGE.

Nous vous conseillons de lire d'abord cette notice avant de commencer la pose. En cas de problème, veuillez contacter votre revendeur Gardival®, qui vous aidera volontairement.

Les outils suivants sont utiles pour la pose de votre VINTAGE à emboîtement:

un tournevis - un crayon - des ciseaux - un niveleur - un mètre (pliant) - un couteau

Nous vous souhaitons beaucoup de succès avec la pose de votre VINTAGE.

Congratulations on your purchase of a Gardival® VINTAGE. Your VINTAGE has been manufactured in high-quality Nordic pine, which may or may not have undergone high-pressure impregnation treatment. Here are the instructions to assemble your VINTAGE. We recommend reading this brochure carefully before starting the assembly of your VINTAGE. If you encounter any problems, please contact your Gardival® salesman, who will be happy to assist you.

You will need the following tools to assemble your VINTAGE quickly and easily:

screwdriver - wood chisel - spirit level - pencil - electric drill - (roll-out) tape measure

We wish you lots of success with the assembly of your VINTAGE.

Felicidades por la compra de su construcción Gardival® en sistema VINTAGE. La construcción VINTAGE está hecho con pino rojo nórdico de alta calidad, que puede estar o no impregnado a presión. Aquí encontrará las indicaciones pertinentes para realizar el montaje.

Antes de proceder al montaje le recomendamos leer atentamente este pequeño manual. En caso de tener problemas no dude en ponerse en contacto con el distribuidor Gardival®, que lo ayudará a solucionar sus problemas.

Usted necesitará las siguientes herramientas para el montaje:

destornillador - cuchilla - tijeretas - nivel - lápiz - taladro - cinta métrica

Le deseamos éxito en el montaje de su construcción.

Herzlichen Glückwunsch zu Ihrer Gardival® VINTAGE. Ihre VINTAGE ist aus hochwertiger nordeuropäischer Kiefer hergestellt, wahlweise mit oder ohne Druckimprägnierung. Anbei die Anleitung zur Selbstmontage Ihrer neuen VINTAGE. Wir empfehlen, diese Broschüre zuerst aufmerksam durchzulesen, bevor Sie mit dem Aufbau der VINTAGE beginnen. Falls Sie weitere Fragen dazu haben sollten,

verweisen wir Sie gerne an Ihren Gardival® Händler, der Ihnen gerne mit Rat und Tat zur Seite steht.

Für einen zügigen Aufbau Ihrer VINTAGE empfehlen wir Ihnen, folgende Hilfsmittel vorzubereiten:

Schraubenzieher - Messer - Holzmeißel - Wasserwaage - Bleistift - Bohrmaschine - Meterstab

Viel Erfolg beim Aufbauen Ihrer VINTAGE.



GARDIVAL®

- 1 De Gardival VINTAGE wordt op een houten vloer geplaatst
Votre abri Gardival VINTAGE est posé sur un plancher de sol en bois
Your Gardival VINTAGE garden house will be installed on a wooden floor
La construcción Gardival VINTAGE se monta sobre un suelo de madera
Die Gardival VINTAGE wird auf einem Holzboden aufgestellt

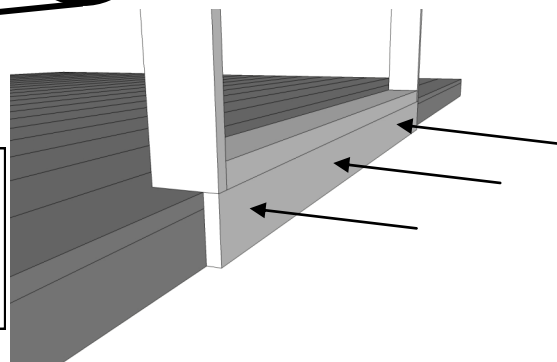
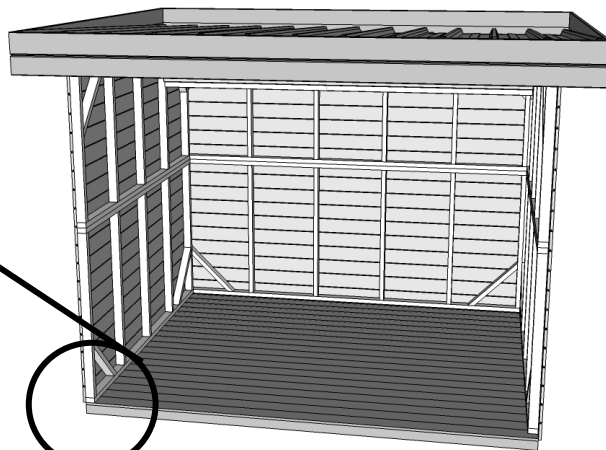
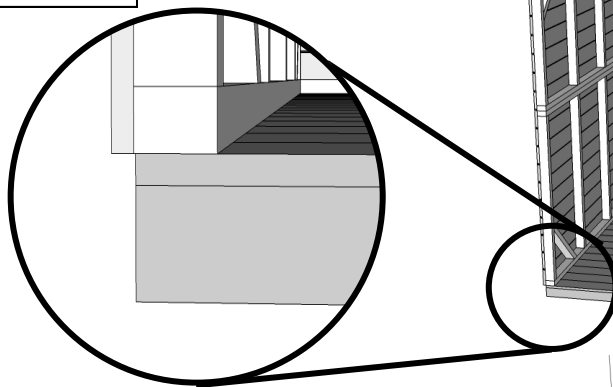
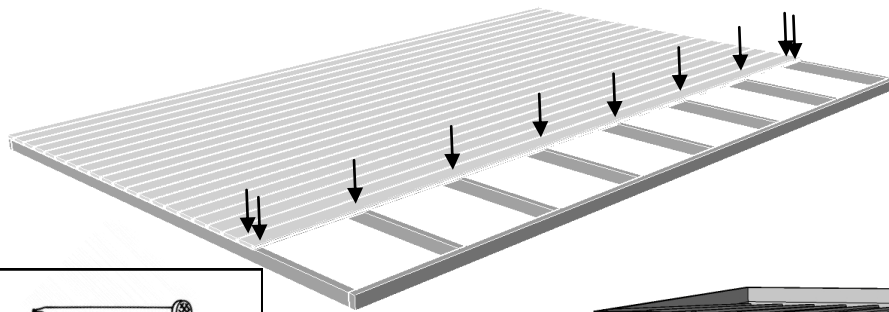
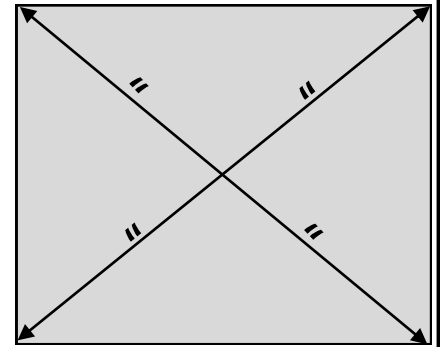
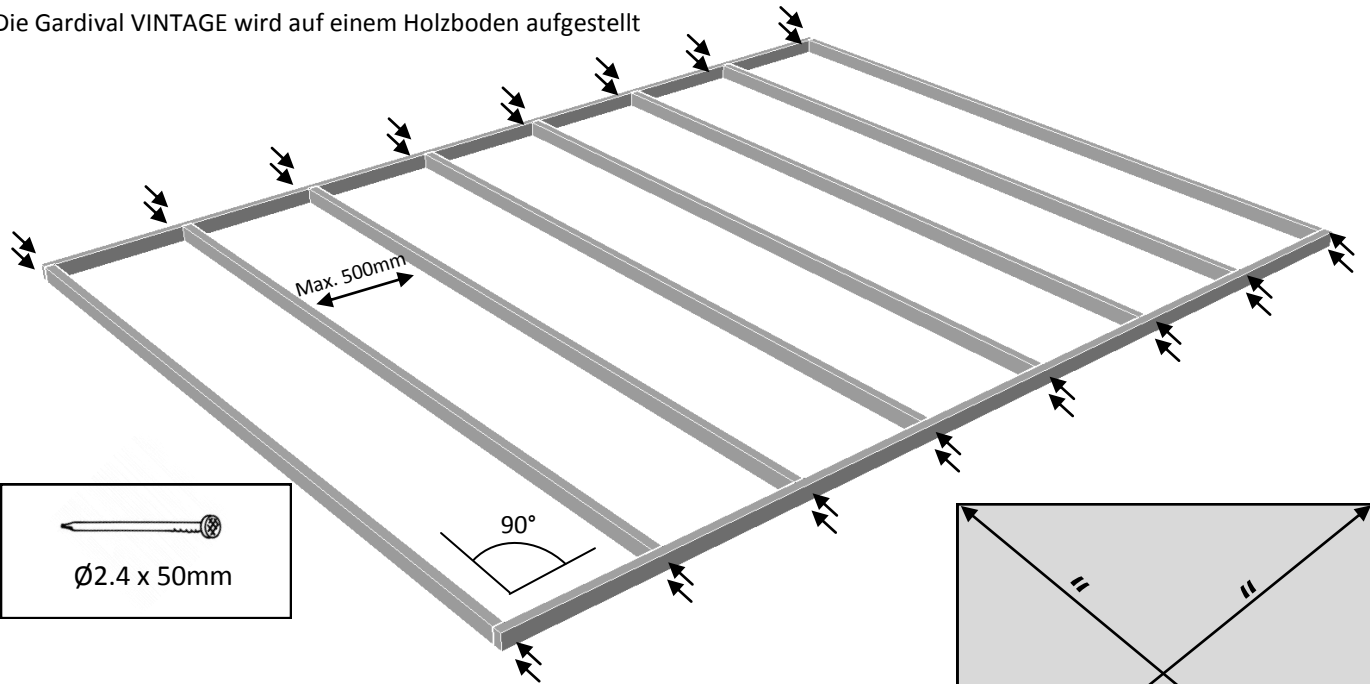

2

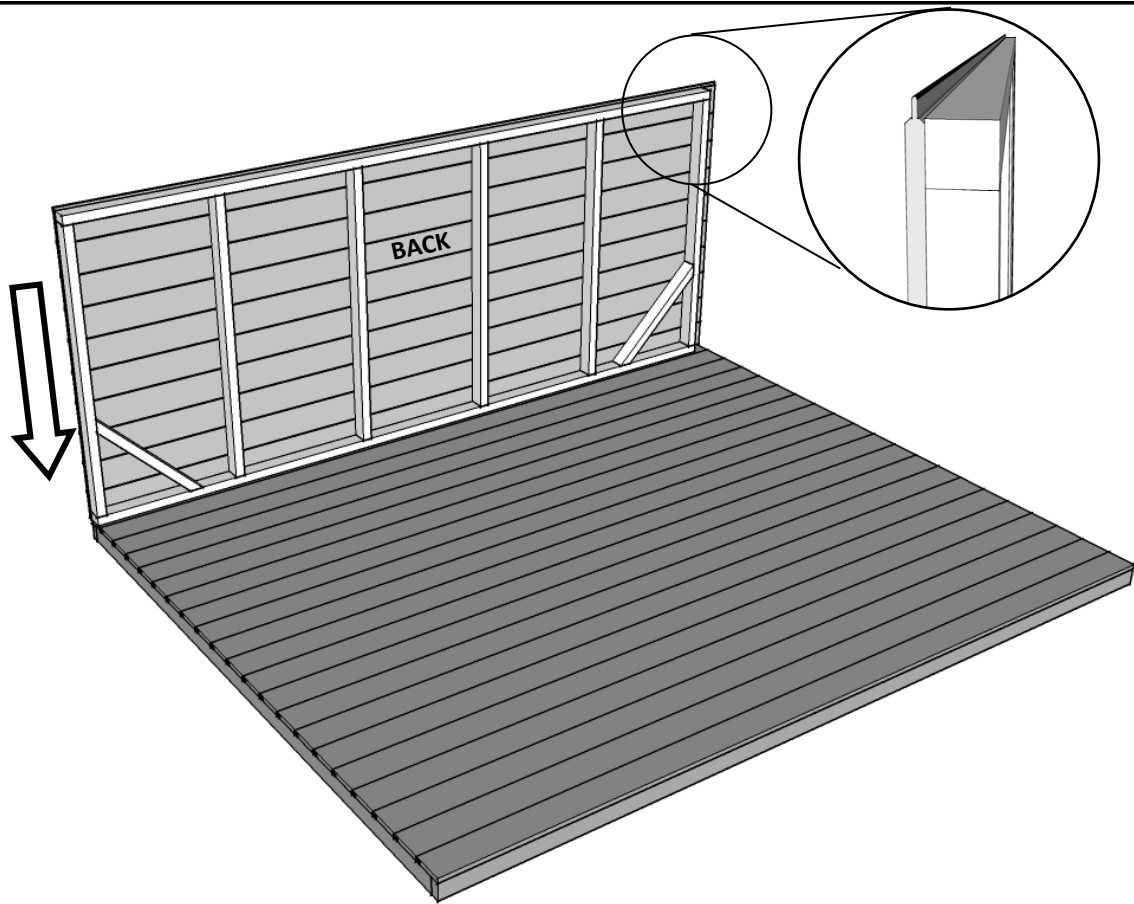

3

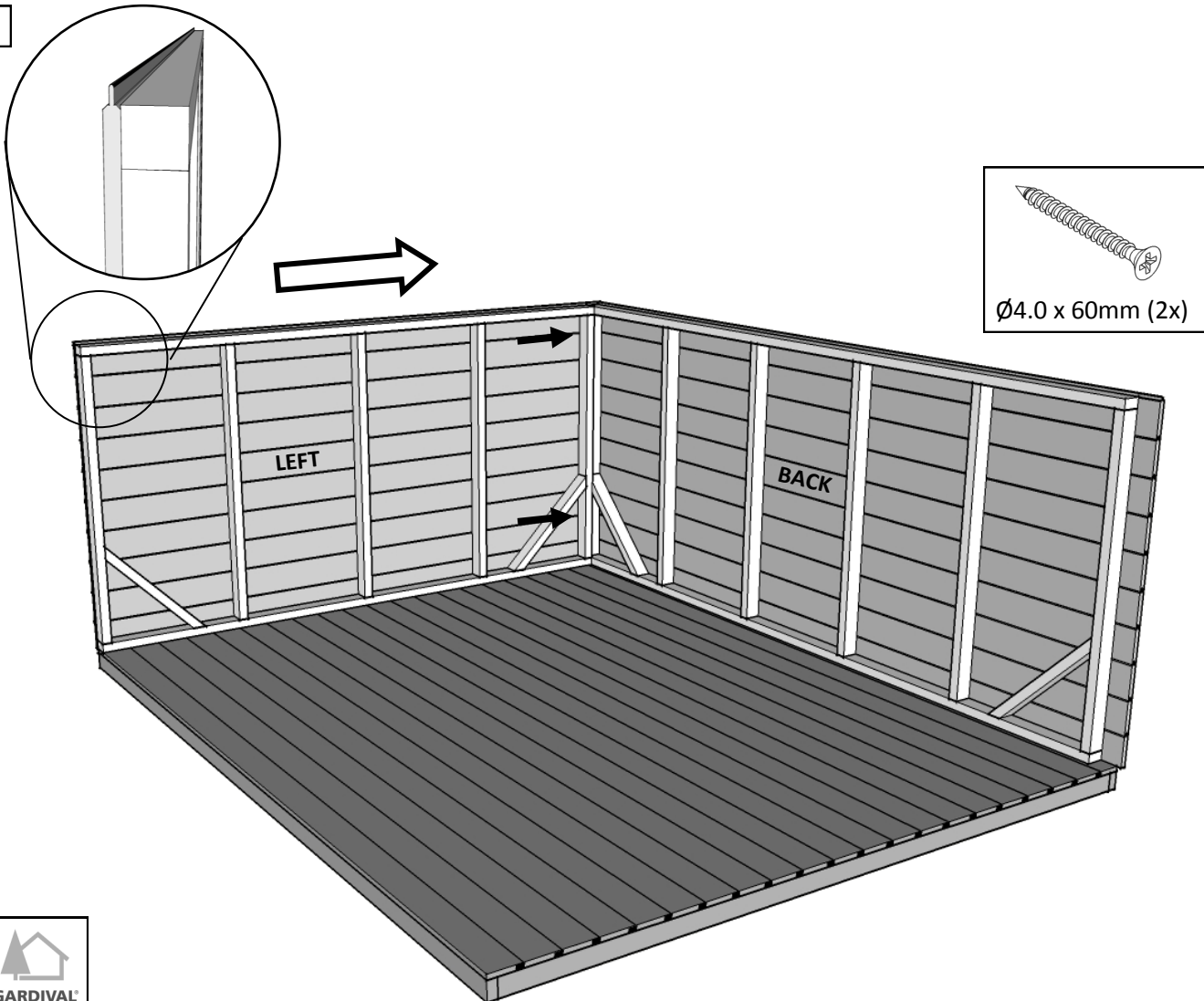

4

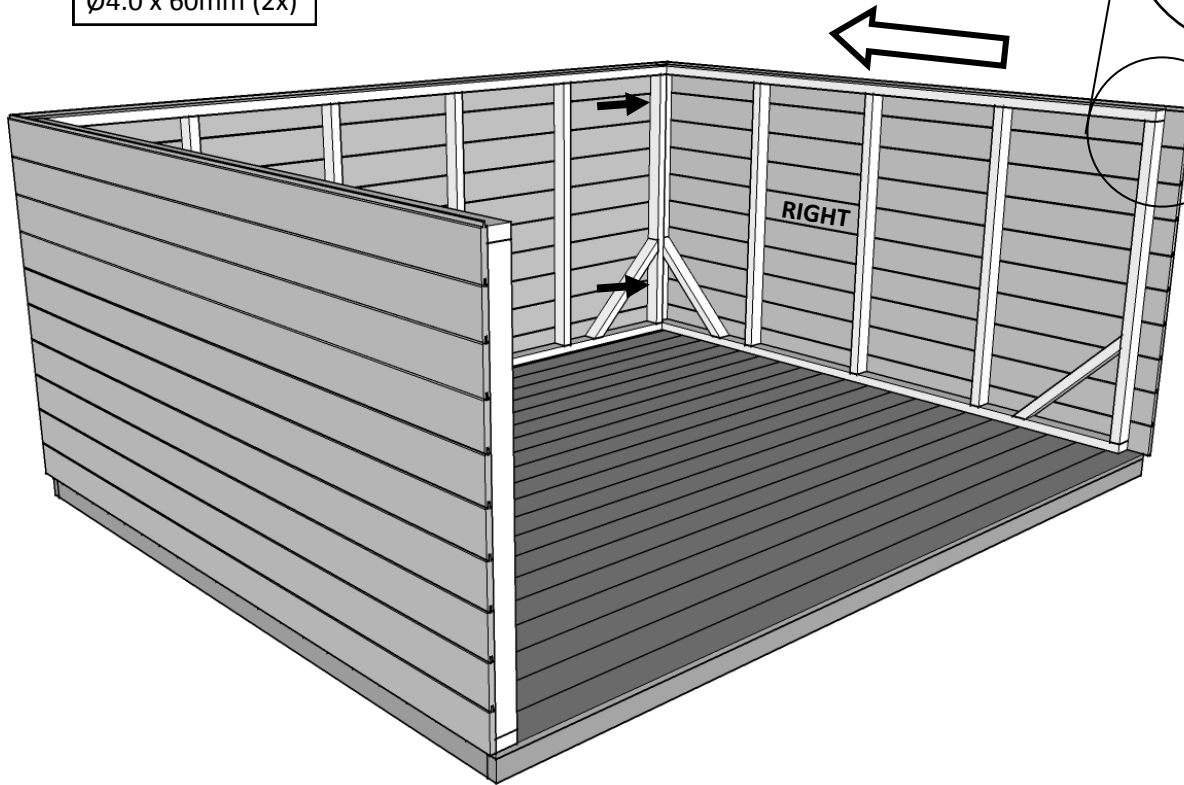
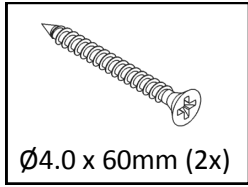

5

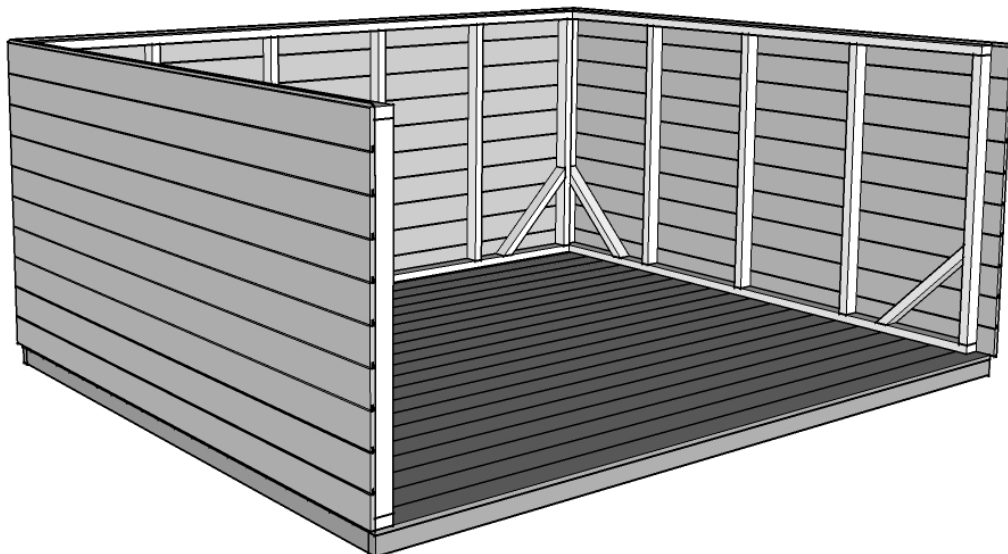
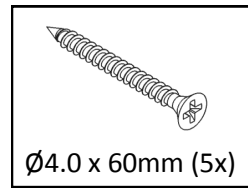
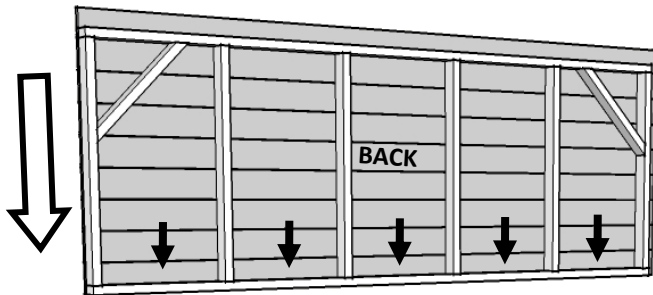

6

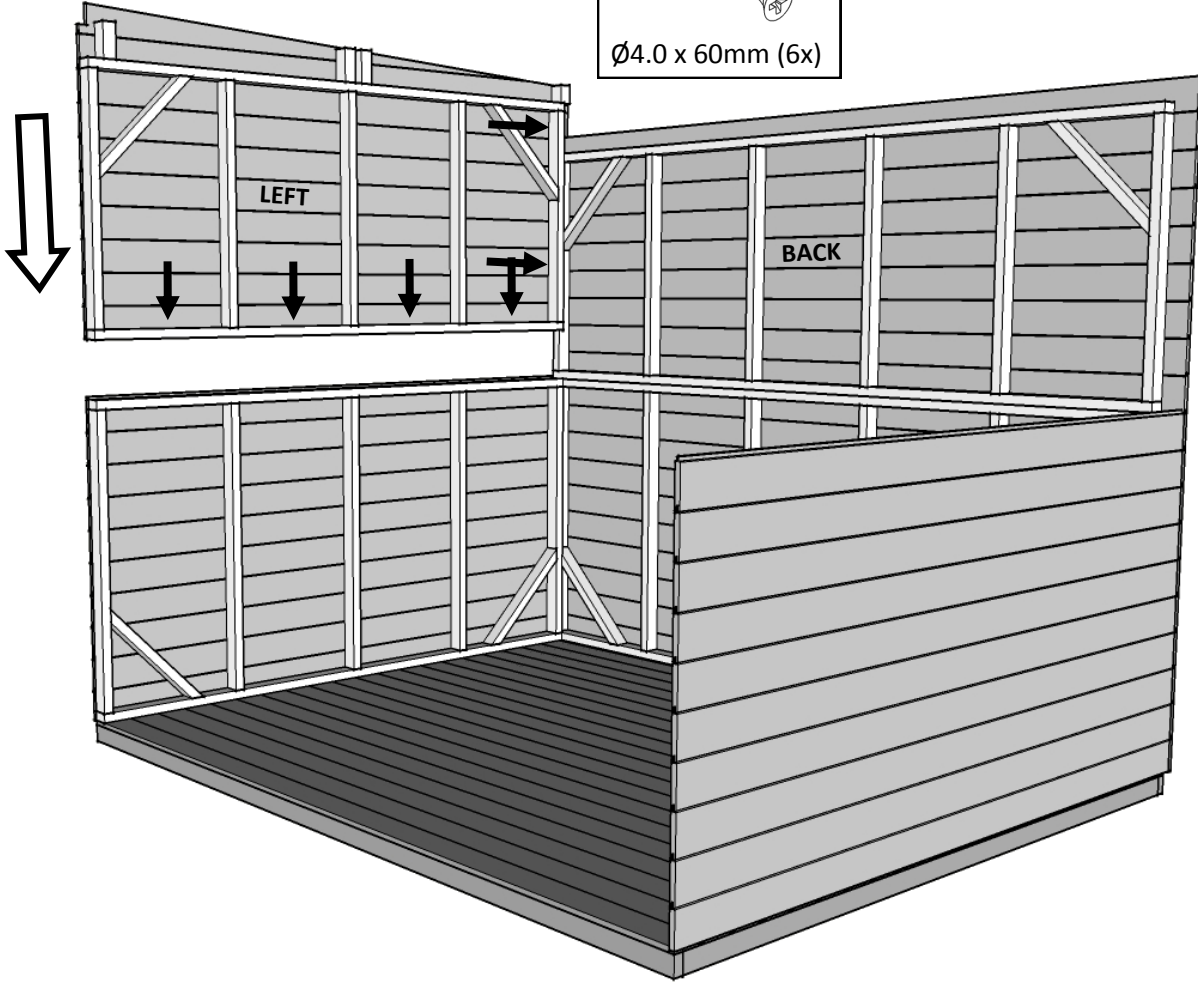
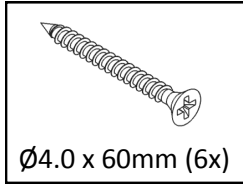

7

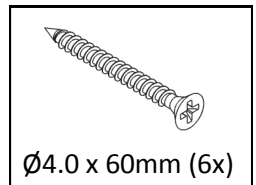
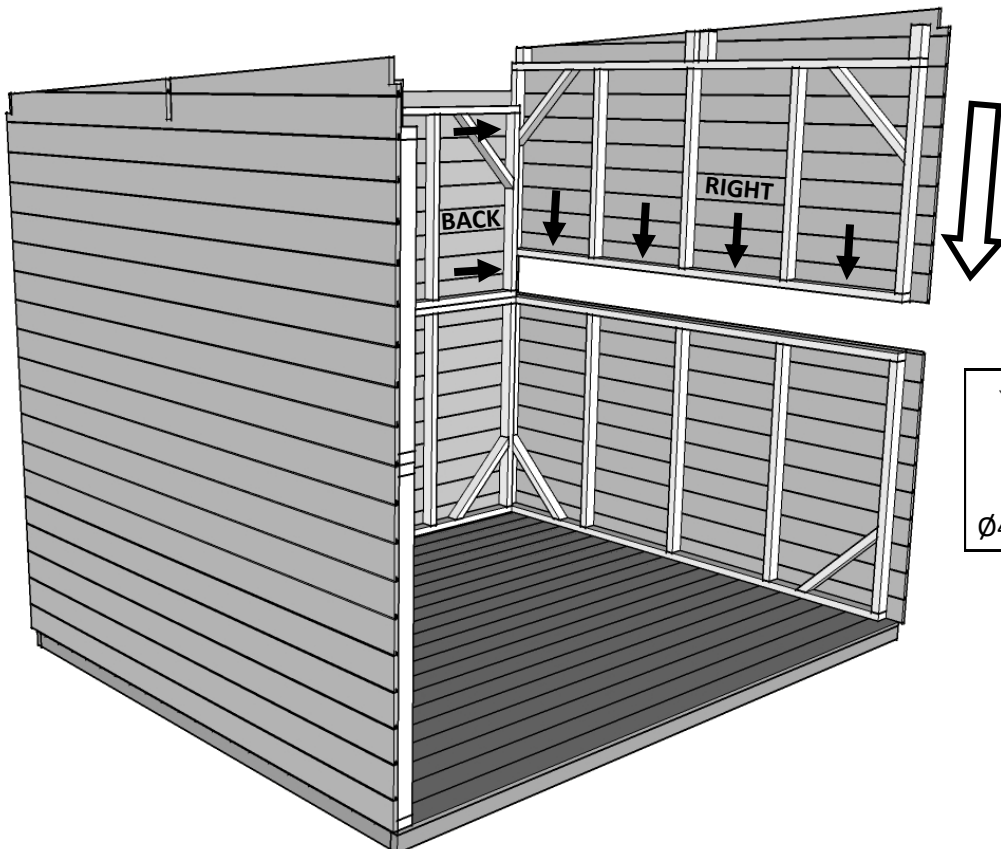

11

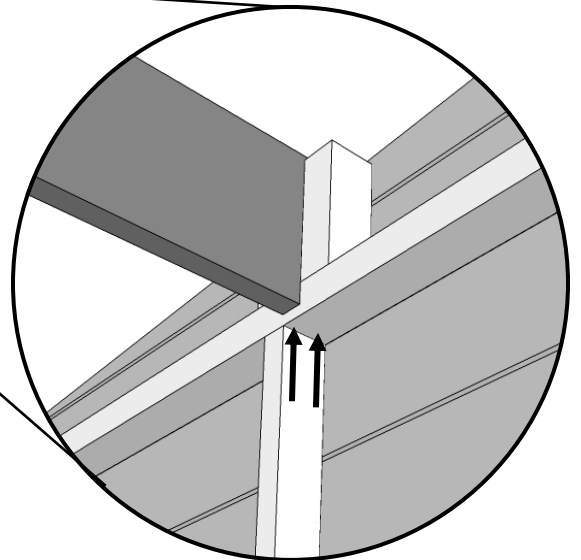
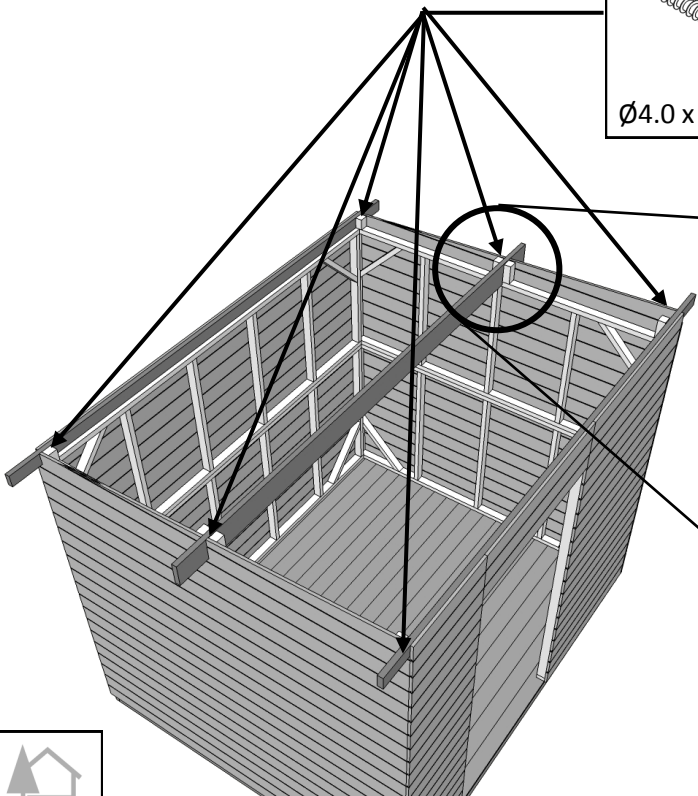
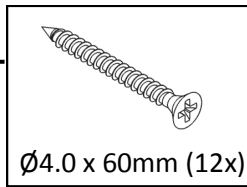
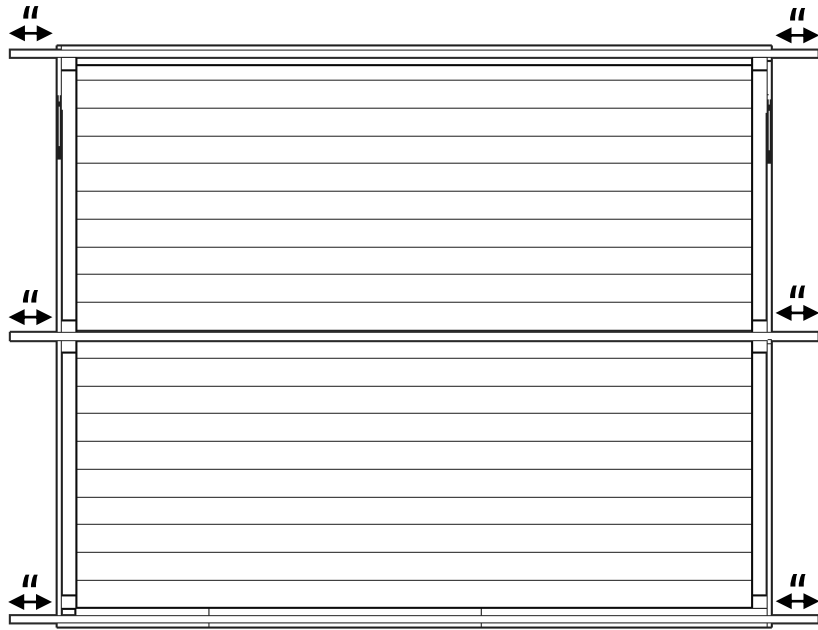
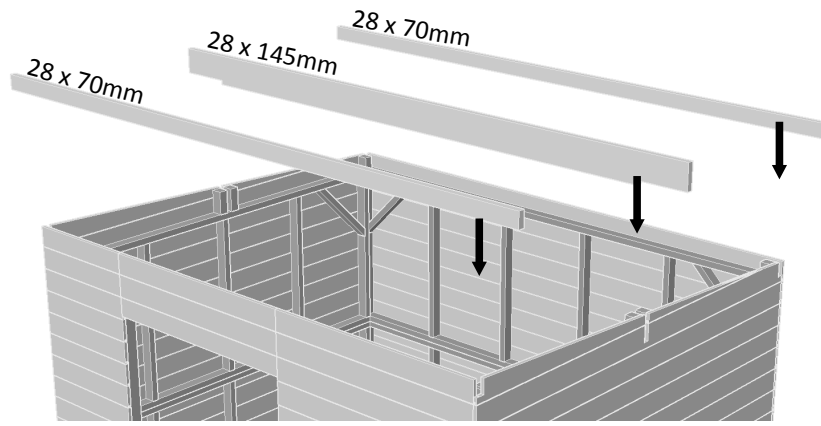

12

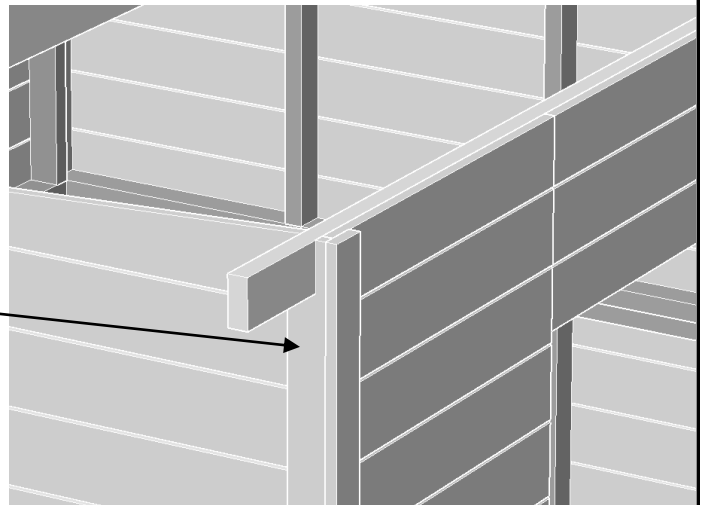
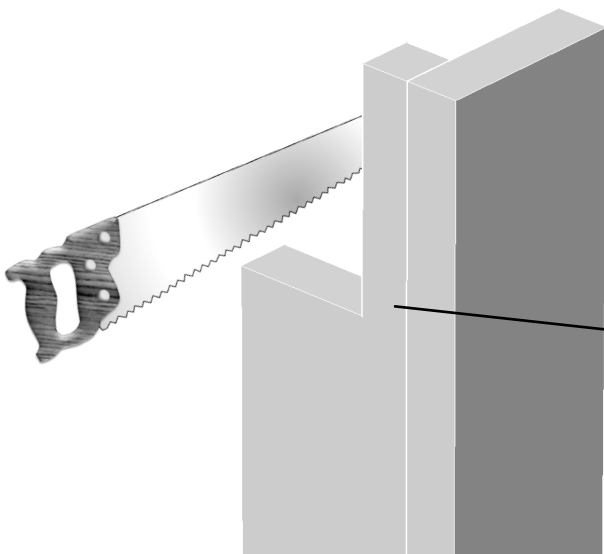
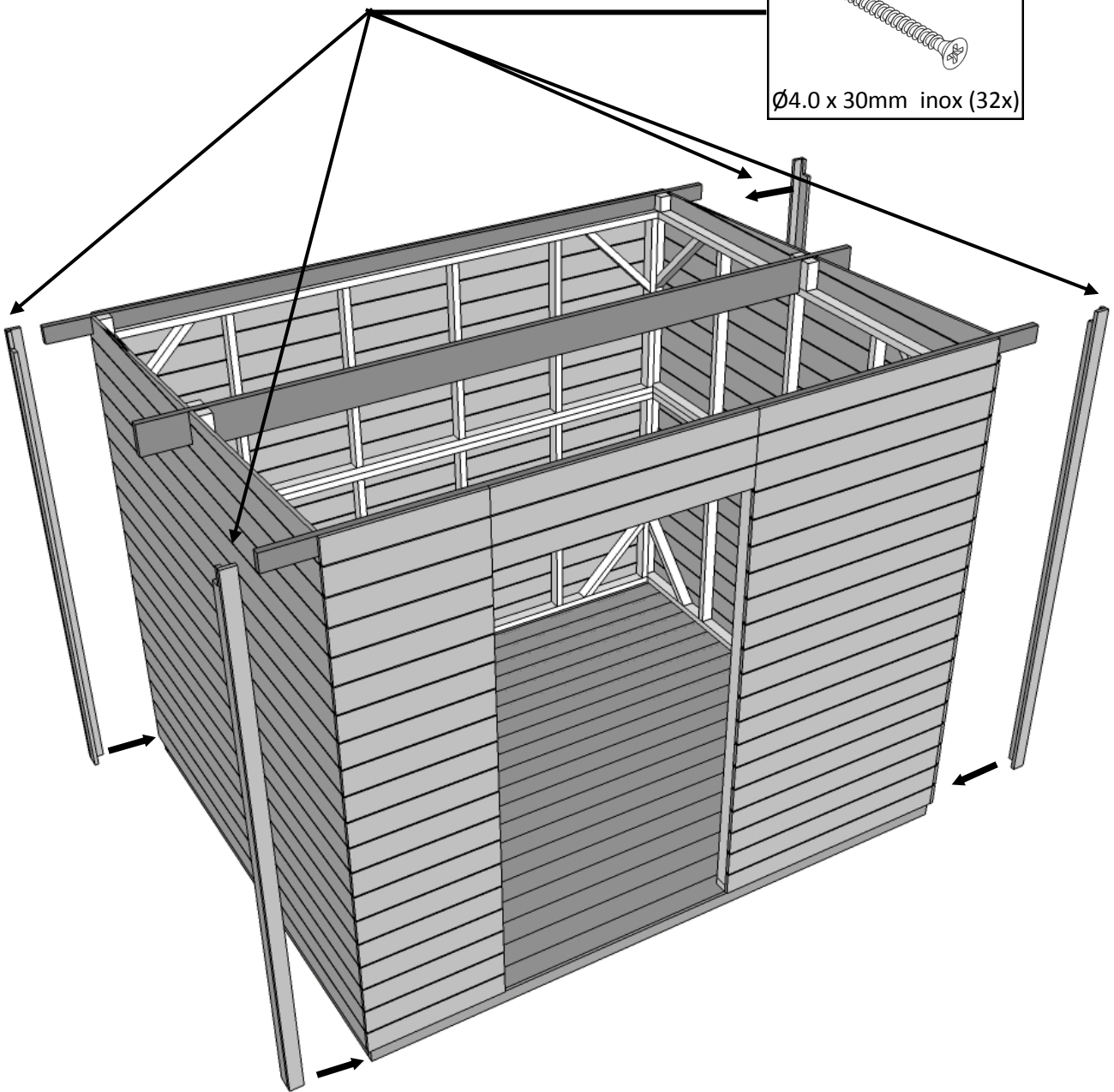
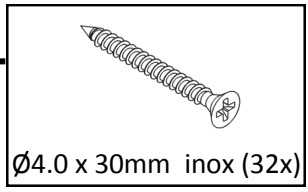

13

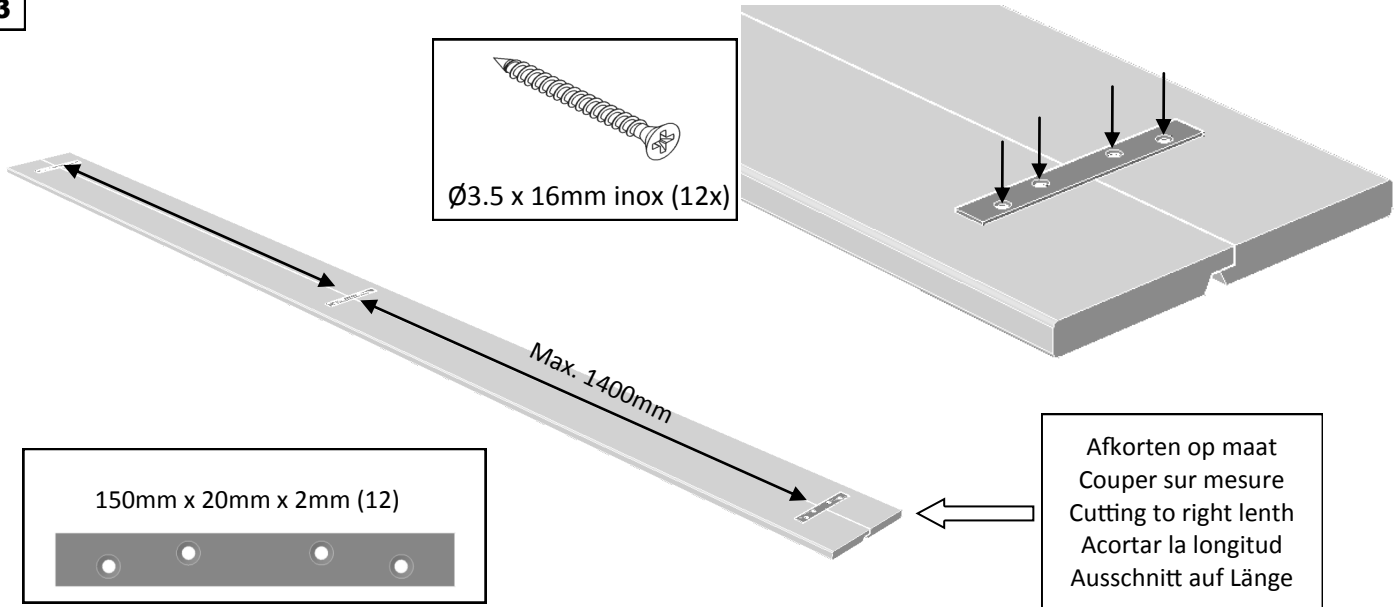

14

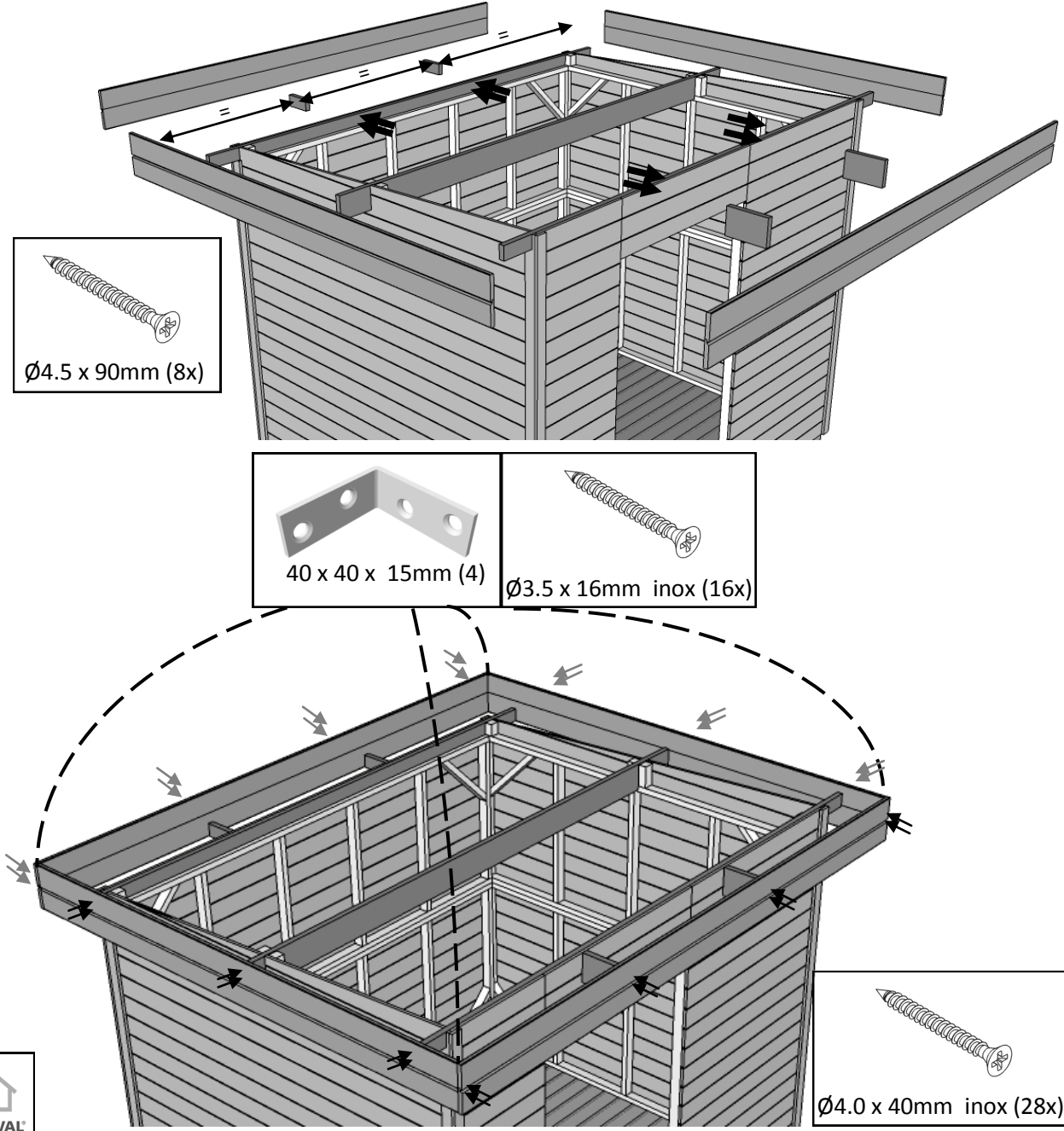

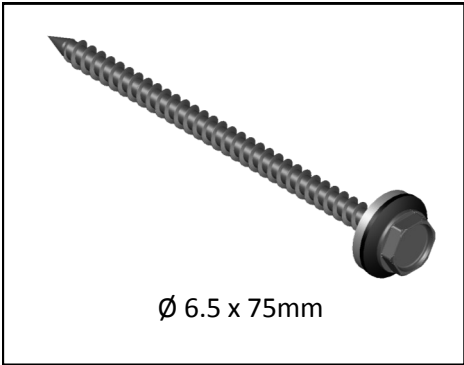
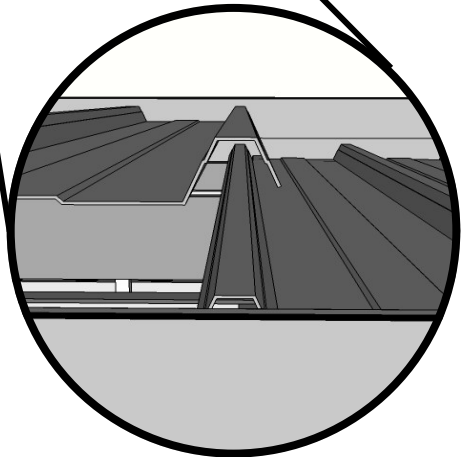
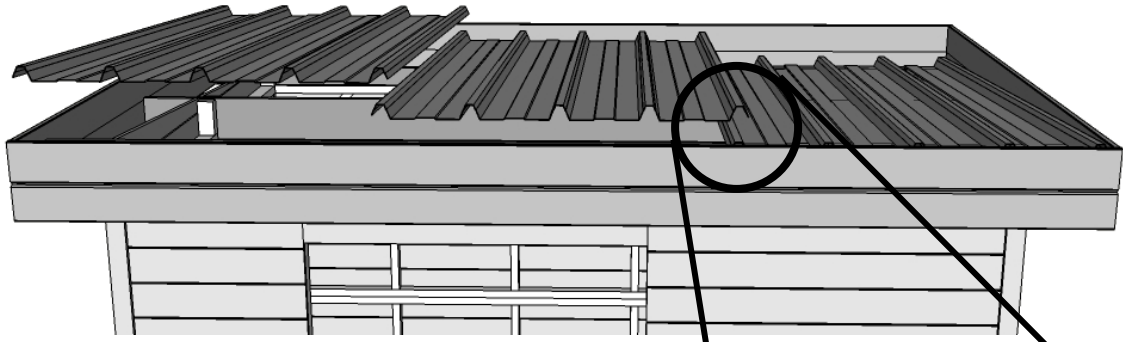

Ø 6.5 x 75mm

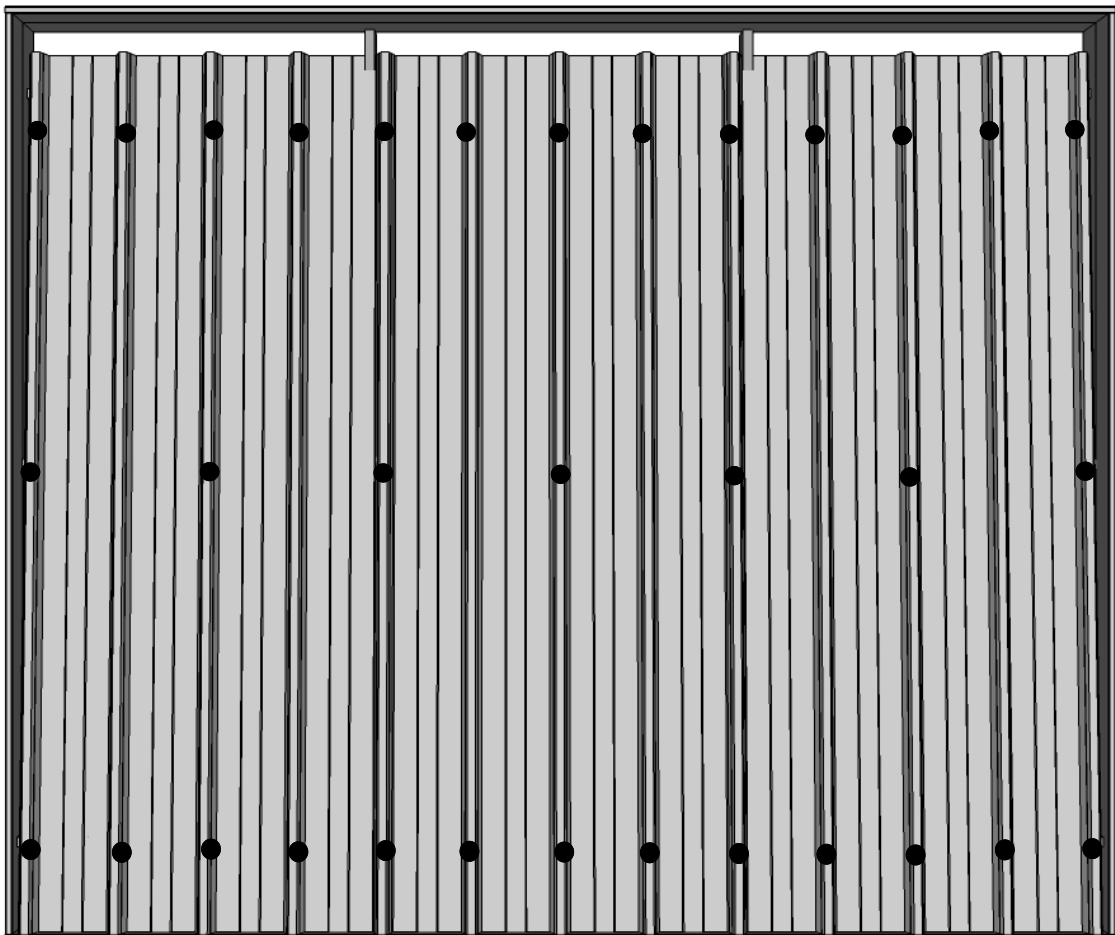

16

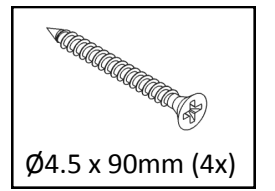
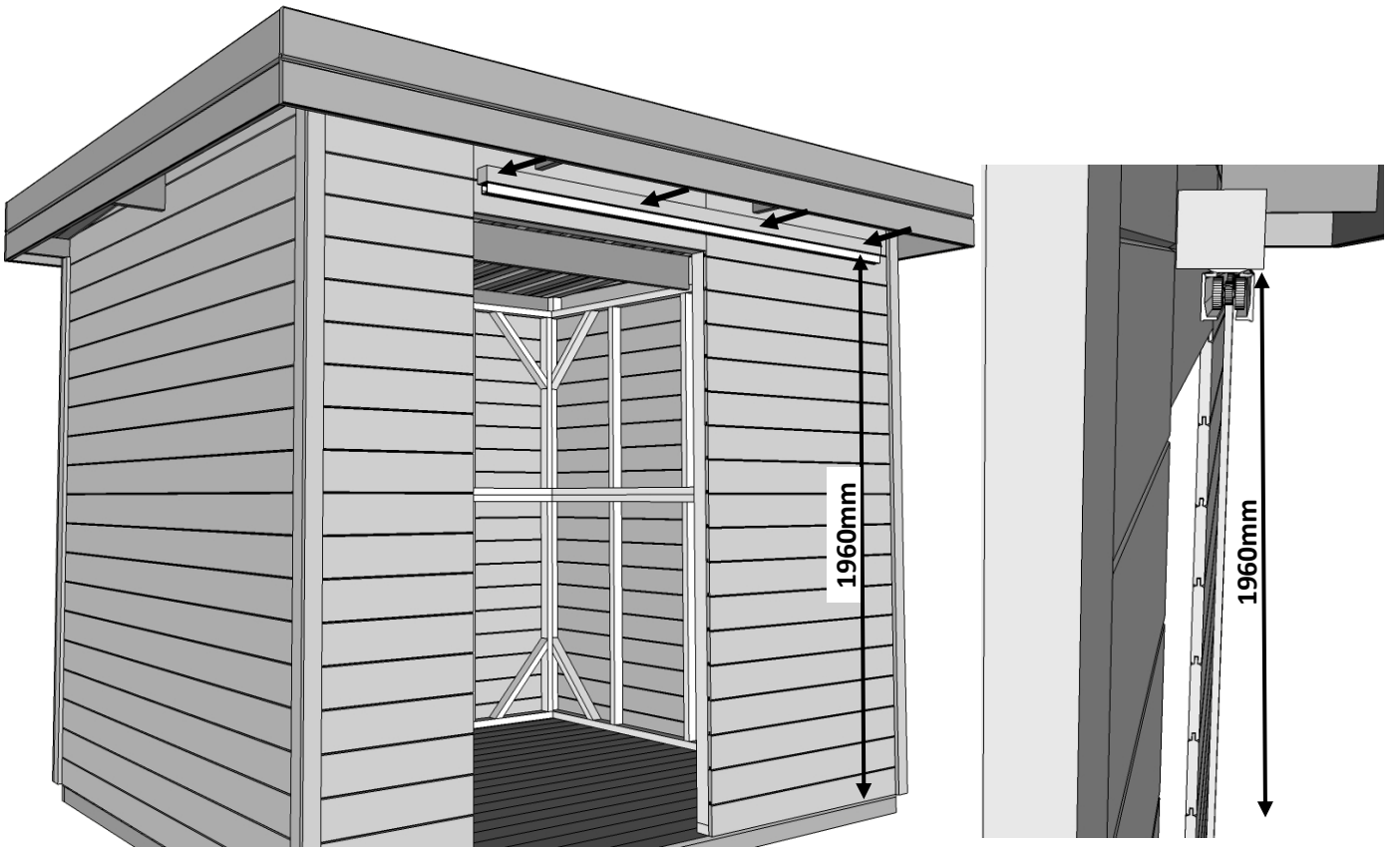
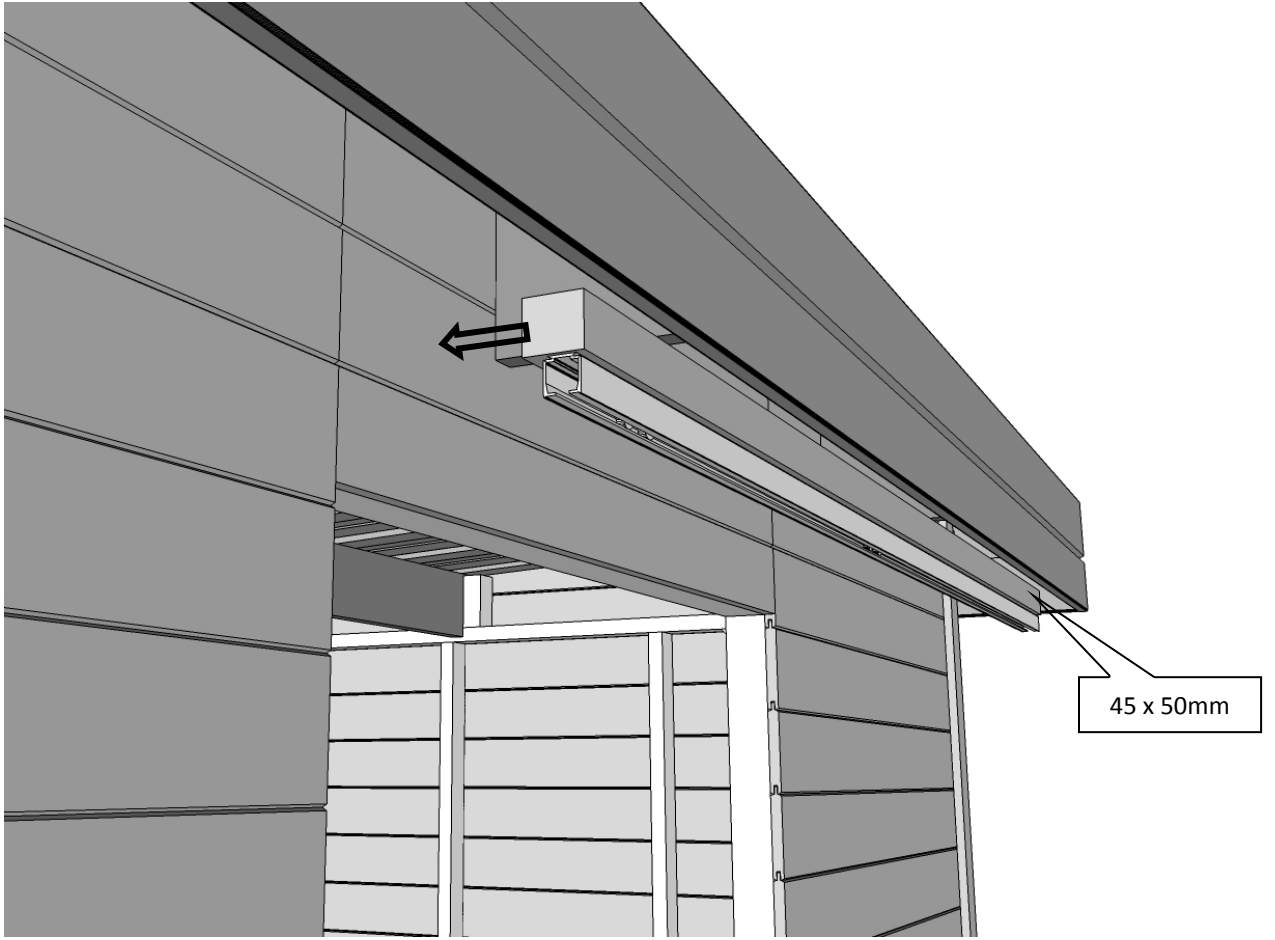

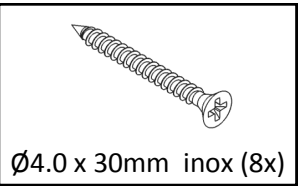
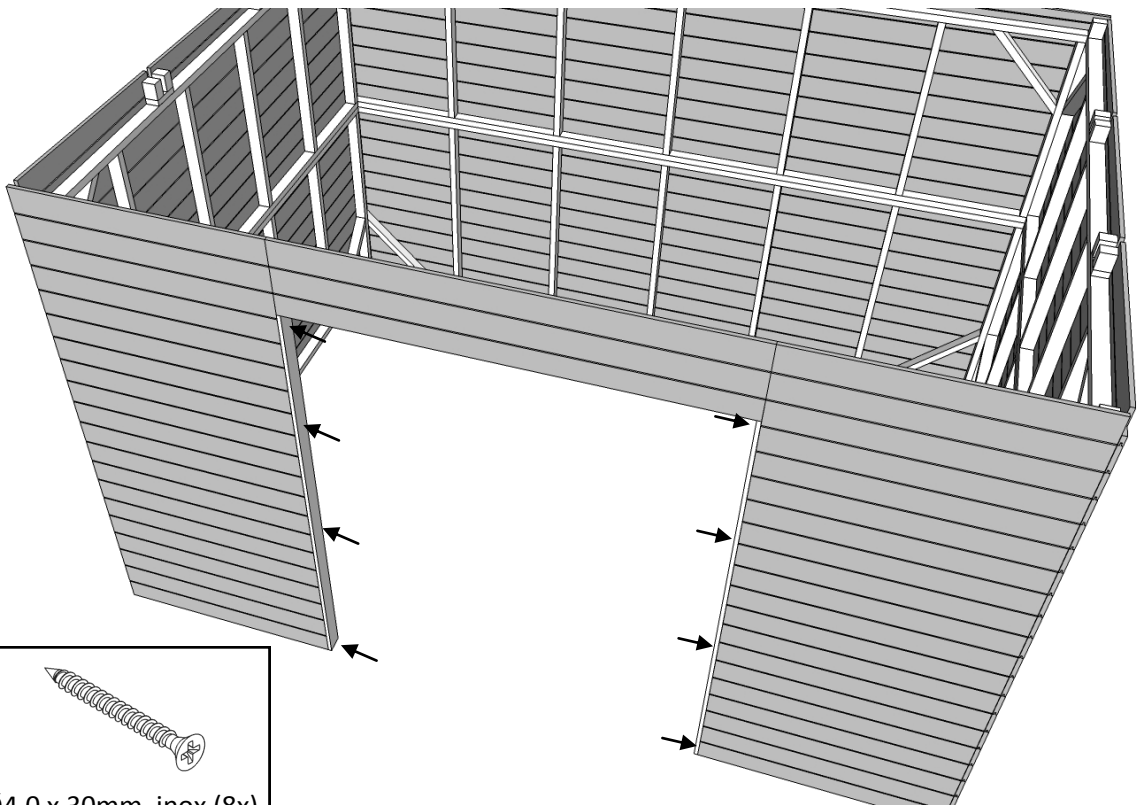
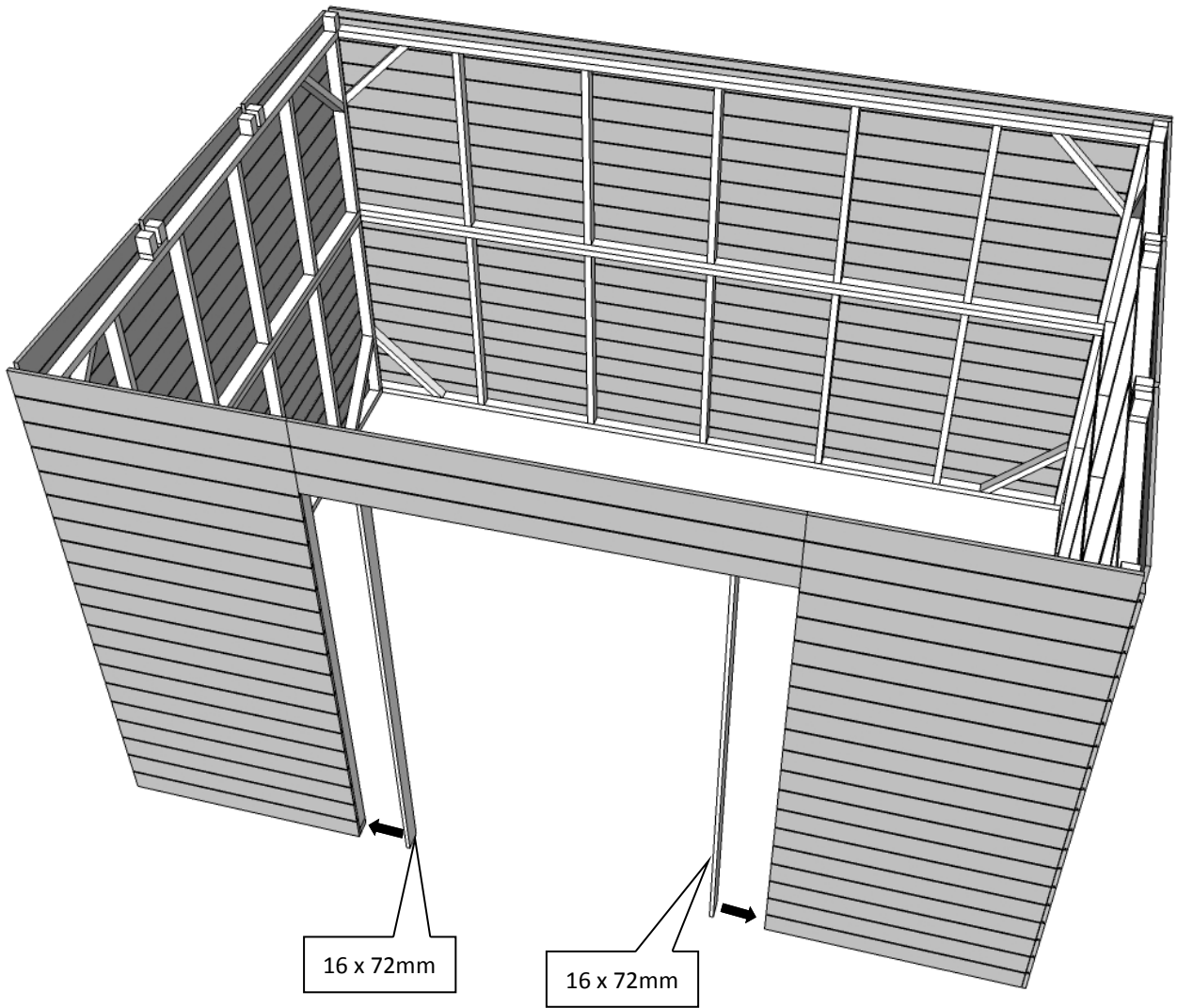

18

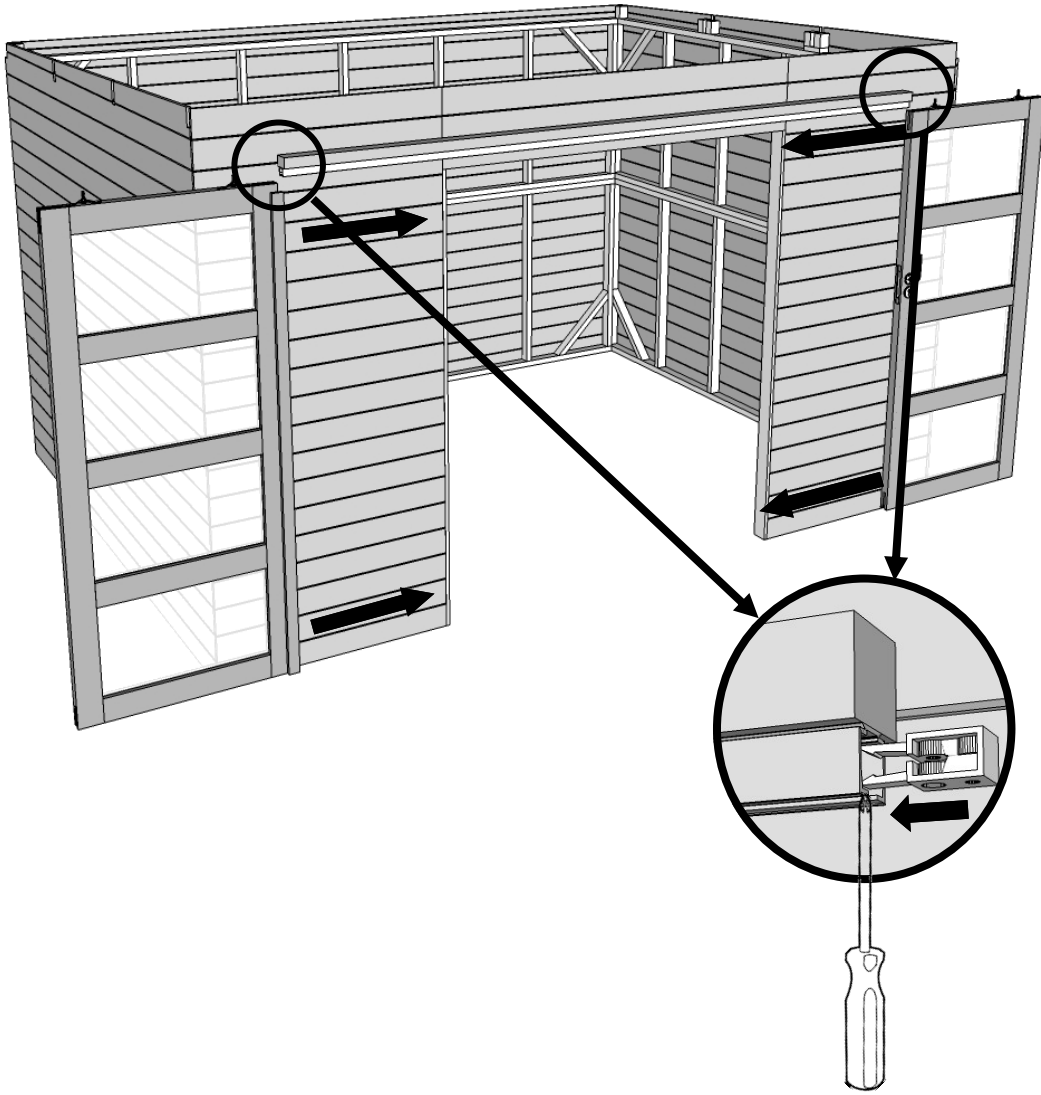

19

